

## DESCRIPTION

The AP64060 is a 600mA, synchronous buck converter with a wide input voltage range of 4.5V to 40V. The device fully integrates a 600mΩ high-side power MOSFET and a 300mΩ low-side power MOSFET to provide high-efficiency step-down DC-DC conversion.

The AP64060 device is easily used by minimizing the external component count due to its adoption of peak current mode control.

The AP64060 design has a proprietary gate driver scheme to resist switching node ringing without sacrificing MOSFET turn-on and turn-off times, which reduces high-frequency radiated EMI noise caused by MOSFET switching.

The device is available in a TSOT26 package.

## FEATURES

- Wide Input Range: 4.5V to 40V
- 600mA Continuous Output Current
- 0.8V  $\pm$ 1% Reference Voltage
- 90μA Low Quiescent Current (Pulse Frequency Modulation)
- 2.2MHz Switching Frequency
- Supports Pulse Frequency Modulation (PFM)
- Proprietary Gate Driver Design for Best EMI Reduction
- Precision Enable Threshold to adjust UVLO
- Protection Circuitry
  - Undervoltage Lockout (UVLO)
  - Output Overvoltage Protection (OVP)
  - Cycle-by-Cycle Peak Current Limit
  - Thermal Shutdown
- **Totally Lead-Free & Fully RoHS Compliant**
- **Halogen and Antimony Free. “Green” Device s**

## APPLICATIONS

- 5V, 12V, and 24V Distributed Power Bus Supplies
- eMeters
- Automotive Devices
- White Goods and Small Home Appliances
- FPGA, DSP, and ASIC Supplies
- General-purpose Point-of-Load Devices

## ABSOLUTE MAXIMUM RATINGS

Symbol	Parameter	Rating	Unit
VIN	Supply Pin Voltage	-0.3 to +42.0 (DC)	V
		-0.3 to +45.0 (400ms)	
V <sub>BST</sub>	Bootstrap Pin Voltage	V <sub>SW</sub> - 0.3 to V <sub>SW</sub> + 6.0	V
V <sub>EN</sub>	Enable/UVLO Pin Voltage	-0.3 to +42.0	V
V <sub>RT/CLK</sub>	RT/CLK Pin Voltage	-0.3 to +6.0	V
V <sub>FB</sub>	Feedback Voltage	-0.3V to +6.0	V
V <sub>COMP</sub>	Compensation Pin Voltage	-0.3 to +6.0	V
V <sub>SW</sub>	Switch Node Voltage	-0.3 to VIN + 0.3 (DC)	V
		-2.5 to VIN + 2.0 (20ns)	
T <sub>J</sub>	Junction Temperature	+160	°C
T <sub>L</sub>	Lead Temperature	+260	°C

## RECOMMENDED OPERATING CONDITIONS

Symbol	Parameter	Min	Max	Unit
VIN	Supply Voltage	3.8	40	V
VOU <sub>T</sub>	Output Voltage	0.8	26	V
T <sub>A</sub>	Ambient Temperature Range (Commercial)	-40	+85	°C
	Ambient Temperature Range (Automobile)	-40	+125	°C
T <sub>J</sub>	Junction Temperature Range (Commercial)	-40	+125	°C
	Junction Temperature Range (Automobile)	-40	+150	°C

## EVALUATION BOARD

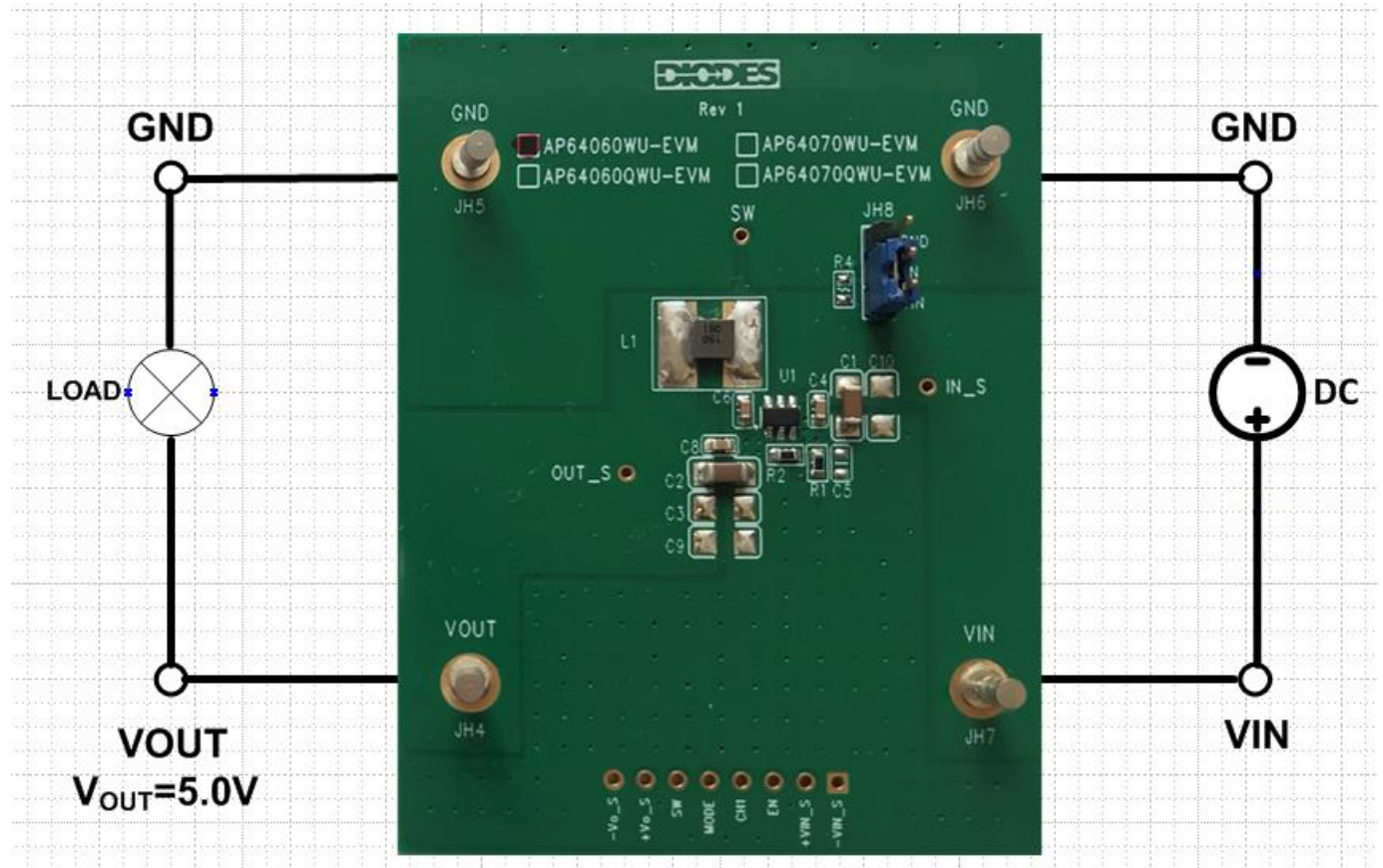

Figure 1. AP64060WU-EVM

## QUICK START GUIDE

The AP64060WU-EVM has a simple layout and allows access to the appropriate signals through test points. To evaluate the performance of the AP64060WU, follow the procedure below:

1. Connect a power supply to the input terminals VIN and GND. Set VIN to 12V.
2. Connect the positive terminal of the electronic load to VOUT and negative terminal to GND.
3. For Enable, at JH8, place a jumper to "VIN" position to connect EN pin directly to VIN. Jump to "GND" position to disable IC.
4. The evaluation board should now power up with a 5.0V output voltage.

5. Check for the proper output voltage of 5.0V ( $\pm 1\%$ ) at the output terminals V<sub>OUT</sub> and GND. Measurement can also be done with a multimeter with the positive and negative leads between V<sub>OUT</sub> and GND.
6. Set the load to 600mA through the electronic load. Check for the stable operation of the SW signal on the oscilloscope. Measure the switching frequency.

### **MEASUREMENT/PERFORMANCE GUIDELINES:**

- 1) When measuring the output voltage ripple, maintain the shortest possible ground lengths on the oscilloscope probe. Long ground leads can erroneously inject high frequency noise into the measured ripple.
- 2) For efficiency measurements, connect an ammeter in series with the input supply to measure the input current. Connect an electronic load to the output for output current.

### **SETTING OUTPUT VOLTAGE:**

Table 1 shows a list of recommended component selections for common output voltages.

V <sub>OUT</sub>	R1	R2	L1	C1	C2
1.8V	27.4K $\Omega$	22.1K $\Omega$	4.7 $\mu$ H	2.2 $\mu$ F	10 $\mu$ F
2.5V	47.5K $\Omega$	22.1K $\Omega$	6.8 $\mu$ H	2.2 $\mu$ F	10 $\mu$ F
3.3V	69.8K $\Omega$	22.1K $\Omega$	8.2 $\mu$ H	2.2 $\mu$ F	10 $\mu$ F
5.0V	115K $\Omega$	22.1K $\Omega$	10 $\mu$ H	2.2 $\mu$ F	10 $\mu$ F
12V	309K $\Omega$	22.1K $\Omega$	22 $\mu$ H	2.2 $\mu$ F	10 $\mu$ Fx3

**Table 1. Common Output Voltages**

### **EVALUATION BOARD SCHEMATIC**

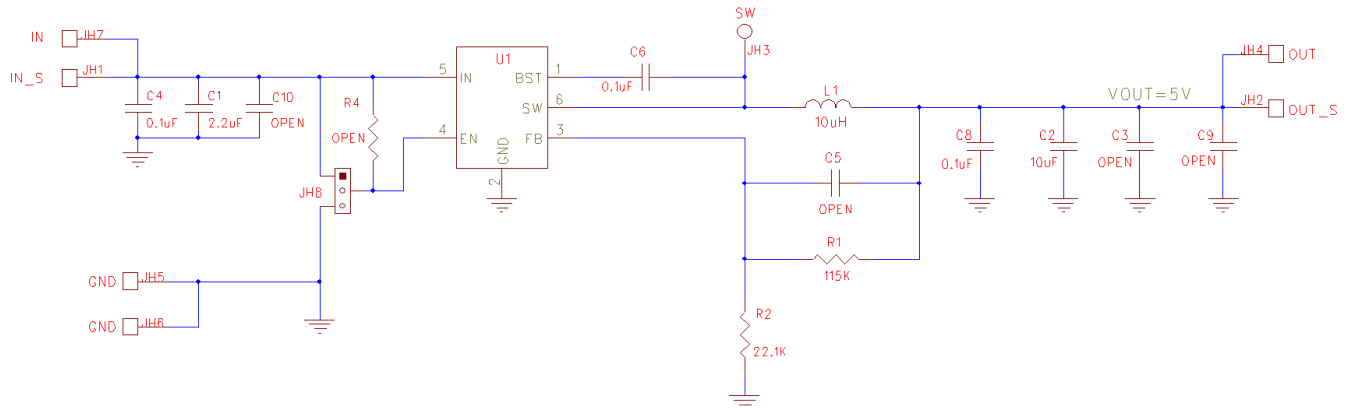

**Figure 2. AP64060WU-EVM Schematic (Commercial)**

**PCB TOP & BOTTOM LAYOUTS**

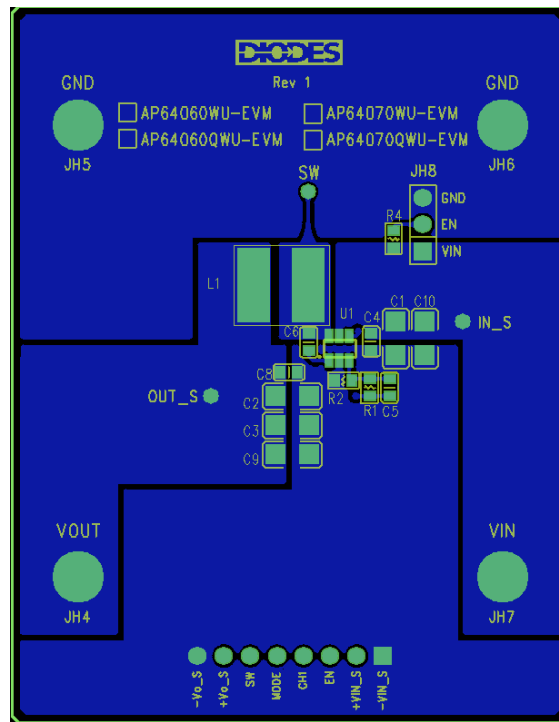

**Figure 3. AP64060WU-EVM – Top Layer**

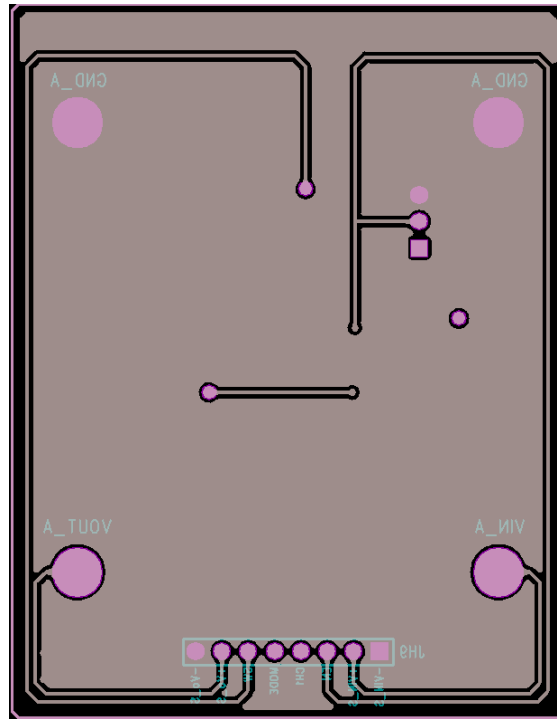
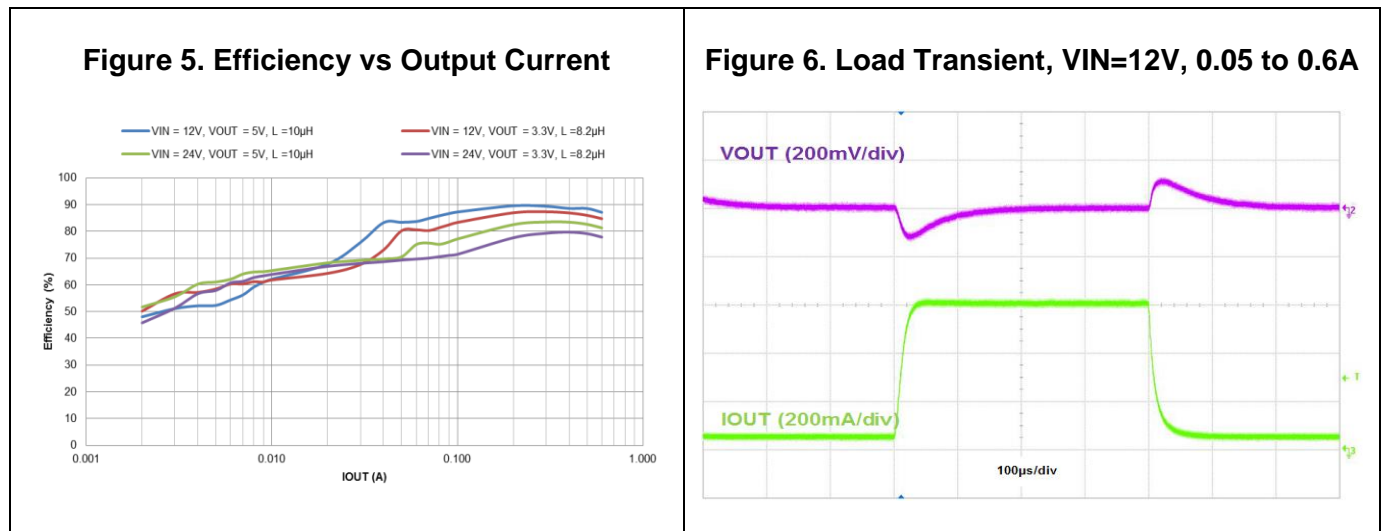

Figure 4. AP64060WU-EVM – Bottom Layer

## BILL OF MATERIALS for AP64060WU-EVM (Commercial) for $V_{OUT}=5V$

Ref	Value	Description	Qty	Size	Vendor Name	Manufacturer PN
C1	2.2 $\mu$ F	Ceramic Capacitor, 50V	1	1206	Murata	GCM31CR71H225K A55L
C4, C6, C8	0.1 $\mu$ F	Ceramic Capacitor, 50V	3	0603	Murata	GCJ188R71H104K A12D
C2	10 $\mu$ F	Ceramic Capacitor, 25V	1	1206	Murata	GRM31CR71E106K A12L
R1	115K $\Omega$	RES SMD	1	0603	Panasonic	ERJ-3RED1153V
R2	22.1K $\Omega$	RES SMD	1	0603	Panasonic	ERJ-3RBD2212V
L1	10 $\mu$ H	DCR=322m $\Omega$ , I <sub>r</sub> =1.2A	1	3.0x3.0x 2.0mm	Würth	78438336100
JH8		PCB Header, 40 POS	1	1X3	3M	2340-6111TG
JH4, JH5, JH6, JH7	1598	Terminal Turret Triple 0.094" L (Test Points)	4	Through-Hole	Keystone Electronics	1598-2
U1	AP64060	Sync DC-DC Buck Converter	1	SO-8EP	Diodes Incorporated (Diodes)	AP64060WU

## TYPICAL PERFORMANCE CHARACTERISTICS



**Figure 7. Output Voltage Ripple, IO<sub>UT</sub>=0.6A**

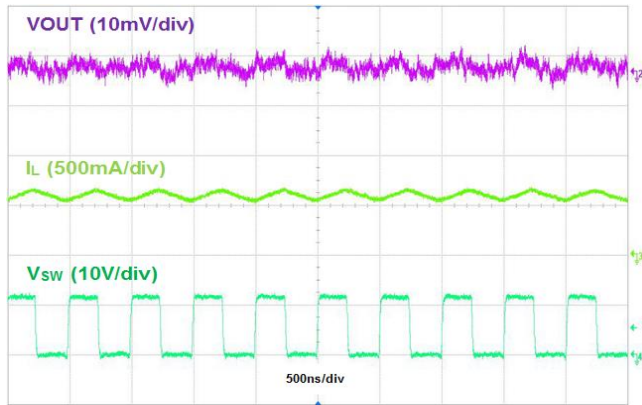

**Figure 8. Output Short Protection, IO<sub>UT</sub>=0.6A**

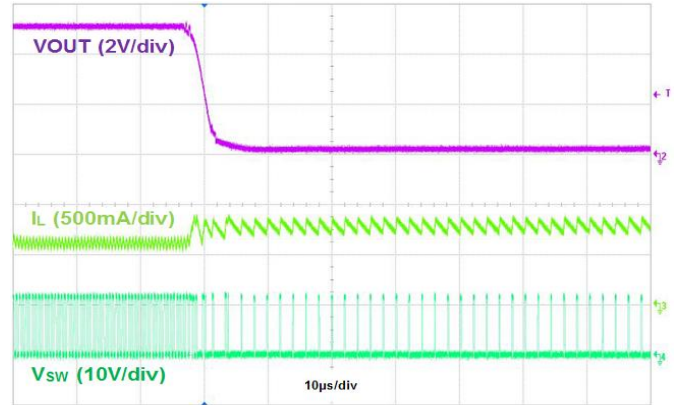



## IMPORTANT NOTICE

1. DIODES INCORPORATED (Diodes) AND ITS SUBSIDIARIES MAKE NO WARRANTY OF ANY KIND, EXPRESS OR IMPLIED, WITH REGARDS TO ANY INFORMATION CONTAINED IN THIS DOCUMENT, INCLUDING, BUT NOT LIMITED TO, THE IMPLIED WARRANTIES OF MERCHANTABILITY, FITNESS FOR A PARTICULAR PURPOSE OR NON-INFRINGEMENT OF THIRD PARTY INTELLECTUAL PROPERTY RIGHTS (AND THEIR EQUIVALENTS UNDER THE LAWS OF ANY JURISDICTION).
2. The Information contained herein is for informational purpose only and is provided only to illustrate the operation of Diodes' products described herein and application examples. Diodes does not assume any liability arising out of the application or use of this document or any product described herein. This document is intended for skilled and technically trained engineering customers and users who design with Diodes' products. Diodes' products may be used to facilitate safety-related applications; however, in all instances customers and users are responsible for (a) selecting the appropriate Diodes products for their applications, (b) evaluating the suitability of Diodes' products for their intended applications, (c) ensuring their applications, which incorporate Diodes' products, comply the applicable legal and regulatory requirements as well as safety and functional-safety related standards, and (d) ensuring they design with appropriate safeguards (including testing, validation, quality control techniques, redundancy, malfunction prevention, and appropriate treatment for aging degradation) to minimize the risks associated with their applications.
3. Diodes assumes no liability for any application-related information, support, assistance or feedback that may be provided by Diodes from time to time. Any customer or user of this document or products described herein will assume all risks and liabilities associated with such use, and will hold Diodes and all companies whose products are represented herein or on Diodes' websites, harmless against all damages and liabilities.
4. Products described herein may be covered by one or more United States, international or foreign patents and pending patent applications. Product names and markings noted herein may also be covered by one or more United States, international or foreign trademarks and trademark applications. Diodes does not convey any license under any of its intellectual property rights or the rights of any third parties (including third parties whose products and services may be described in this document or on Diodes' website) under this document.
5. Diodes' products are provided subject to Diodes' Standard Terms and Conditions of Sale (<https://www.diodes.com/about/company/terms-and-conditions/terms-and-conditions-of-sales/>) or other applicable terms. This document does not alter or expand the applicable warranties provided by Diodes. Diodes does not warrant or accept any liability whatsoever in respect of any products purchased through unauthorized sales channel.
6. Diodes' products and technology may not be used for or incorporated into any products or systems whose manufacture, use or sale is prohibited under any applicable laws and regulations. Should customers or users use Diodes' products in contravention of any applicable laws or regulations, or for any unintended or unauthorized application, customers and users will (a) be solely responsible for any damages, losses or penalties arising in connection therewith or as a result thereof, and (b) indemnify and hold Diodes and its representatives and agents harmless against any and all claims, damages, expenses, and attorney fees arising out of, directly or indirectly, any claim relating to any noncompliance with the applicable laws and regulations, as well as any unintended or unauthorized application.
7. While efforts have been made to ensure the information contained in this document is accurate, complete and current, it may contain technical inaccuracies, omissions and typographical errors. Diodes does not warrant that information contained in this document is error-free and Diodes is under no obligation to update or otherwise correct this information. Notwithstanding the foregoing, Diodes reserves the right to make modifications, enhancements, improvements, corrections or other changes without further notice to this document and any product described herein. This document is written in English but may be translated into multiple languages for reference. Only the English version of this document is the final and determinative format released by Diodes.
8. Any unauthorized copying, modification, distribution, transmission, display or other use of this document (or any portion hereof) is prohibited. Diodes assumes no responsibility for any losses incurred by the customers or users or any third parties arising from any such unauthorized use.
9. This Notice may be periodically updated with the most recent version available at <https://www.diodes.com/about/company/terms-and-conditions/important-notice>

The Diodes logo is a registered trademark of Diodes Incorporated in the United States and other countries.  
All other trademarks are the property of their respective owners.  
© 2024 Diodes Incorporated. All Rights Reserved.

[www.diodes.com](http://www.diodes.com)

