

AL8400EV1 EVALUATION BOARD USER GUIDE

DESCRIPTION

The AL8400EV1, Figure 1, is a double sided evaluation board for the AL8400 linear LED driver. The evaluation board is preset to drive 150mA through the LED string, the maximum number of which depends on their total forward voltage drop.

The operating voltage is between 4 and 18 volts, depending on the LED string to be driven. Higher voltages for longer LED strings can be used by tapping off the board Vin from an intermediate point in the LED string.

Note: The evaluation board does not have reverse supply protection.

The sense resistor R2 of 300mΩ sets the LEDs nominal current at 150mA.

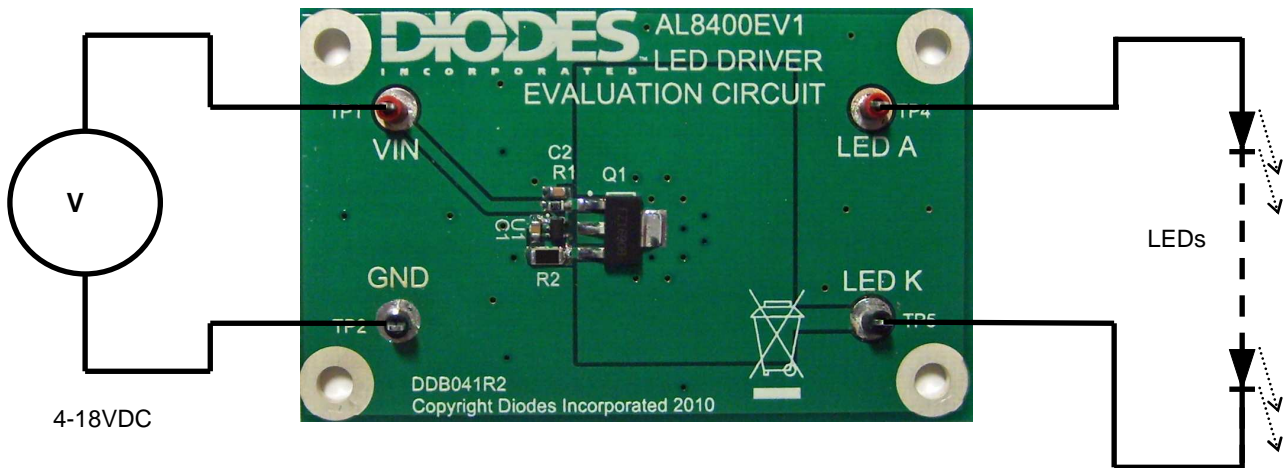

Figure 1: AL8400EV1 evaluation board and connection diagram

AL8400EV1 Connection Point Definition	
Name	Description
Vin	Positive supply voltage. 4 to 18V
GND	Supply Ground (0V)
LED A	LED A connects to the external LED string anode
LED K	LED K connects to the external LED string cathode

AL8400 DEVICE DESCRIPTION

The AL8400 is a 5-terminal adjustable Linear LED driver controller offering excellent temperature stability and output handling capability. The AL8400 simplifies the design of linear and isolated LED drivers. With its low 0.2V FB pin, it controls the regulation of LED current with minimal power dissipation when compared to traditional linear LED drivers. This makes it ideal for medium to high current LED driving.

AL8400 DEVICE FEATURES

- Low reference voltage ($V_{FB} = 0.2V$)
- -40 to 125°C temperature range
- 3% Reference voltage tolerance at 25°C
- Low temperature drift
- 0.2V to 18V open-collector output
- High power supply rejection (>45dB at 300kHz)

DEVICE APPLICATIONS

- Isolated offline LED converters
- Linear LED driver
- LED signs
- Instrumentation illumination

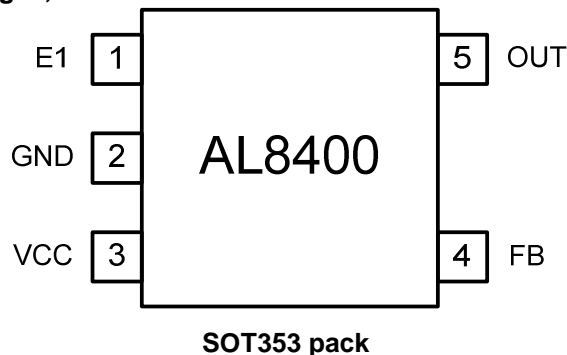
AL8400 Device Packages, Pin and Definitions**AL8805 Device Pin Definition**

Name	Pin No	Description
E1	1	Emitter connection. Connect to GND.
GND	2	Analog Ground: Ground return for reference and amplifier. Connect to E1.
V _{CC}	3	Supply Input. Connect a 0.47μF ceramic capacitor close to the device from VCC to GND.
FB	4	Feedback Input. Regulates to 200mV nominal.
OUT	5	Output. Connect a capacitor close to device between OUT and GND.

ORDERING INFORMATION

EVALBOARD ORDER NUMBER
AL8400EV1

DEVICE ORDER NUMBER
AL8400SE-7

Please note: Evaluation boards are subject to availability and qualified sales leads.

AL8400EV1 EVALUATION BOARD REFERENCE DESIGN

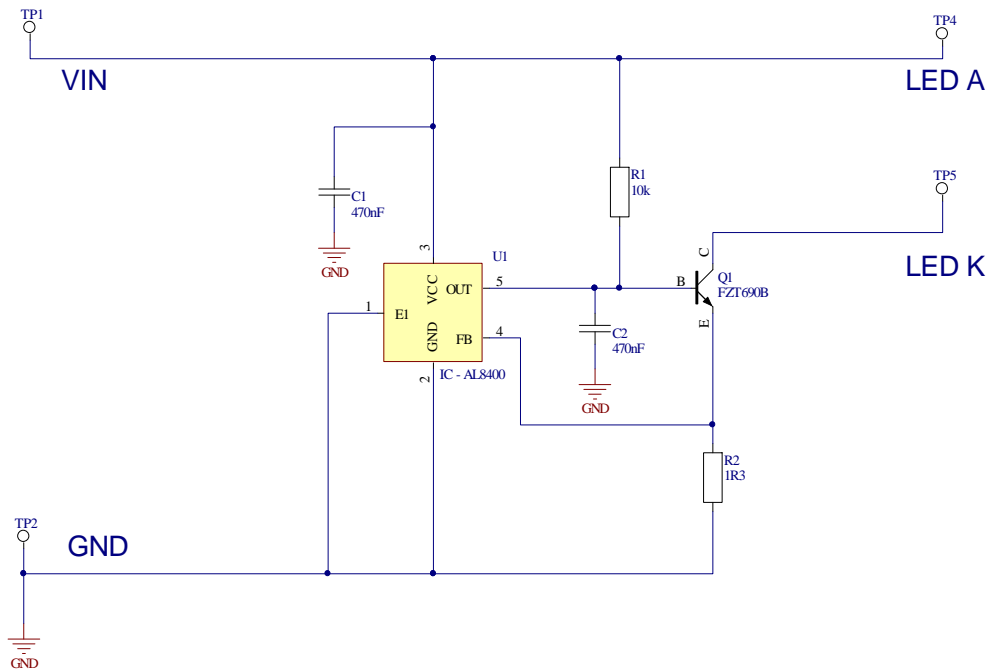

Figure 2: AL8400EV1 Schematic

The AL8400 provides a simple linear LED driver in the form of a constant current circuit. The device will drive the base of the external transistor, Q1, appropriately to maintain a voltage of 0.2V at the FB pin. Choosing the value of R2 allows the current in the LED string (and through Q1 and R2) to be selected.

The board comes preset to 150mA LED current with R2 at 1.3ohms:

$$I_{LED} = 0.2 \div 1.3 = 0.154A$$

The AL8400 will tolerate a maximum voltage of 18V at its VCC input, but it can be used over an extended voltage range by taking Vin from an intermediate point in the LED String:

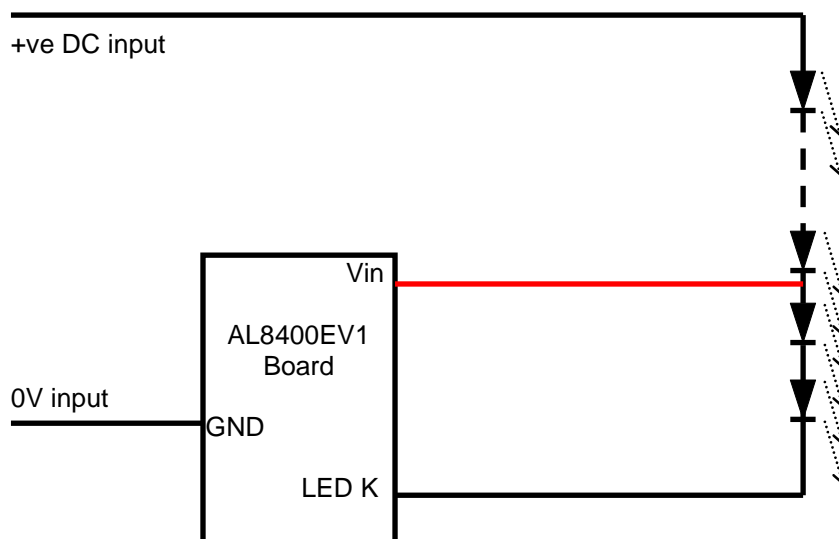

Figure 3: Extended Voltage Range connection diagram

Bill of Materials

QUANTITY	PCB IDENT	VALUE	DESCRIPTION	SUGGESTED SOURCE
1	N/A	DDB041R1	PCB	Diodes Zetex
1	U1	AL8400		Diodes Zetex
1	Q1	FZT690B		Diodes Zetex
2	C1,C2	470nF	0603 Ceramic Capacitor	Generic
1	R1	10k	0603 Resistor	Generic
1	R2	1R3	1206 Resistor	Generic

Circuit Accuracy.

The accuracy of the circuit is determined by the accuracy of the device (+/- 5% over temp) and the accuracy of the current sensing resistor (Typ +/- 1%).

For the circuit as set the nominal current is 154mA ($0.2/1.3 = 0.15384\dots$). The worst cases are 163mA ($0.210/1.287 = 0.16317\dots$) and 144mA ($0.19/1.313 = 0.14470\dots$). This gives approx 10mA possible variation over the nominal 154mA, about 6.5%.

For Further information please contact your Diodes Inc representative.

INTENTIONALLY BLANK

INTENTIONALLY BLANK

INTENTIONALLY BLANK

IMPORTANT NOTICE

DIODES INCORPORATED MAKES NO WARRANTY OF ANY KIND, EXPRESS OR IMPLIED, WITH REGARD TO THIS DOCUMENT, INCLUDING, BUT NOT LIMITED TO, THE IMPLIED WARRANTIES OF MERCHANTABILITY AND FITNESS FOR A PARTICULAR PURPOSE (AND THEIR EQUIVALENTS UNDER THE LAWS OF ANY JURISDICTION).

Diodes Incorporated and its subsidiaries reserve the right to make modifications, enhancements, improvements, corrections or other changes without further notice to this document and any product described herein. Diodes Incorporated does not assume any liability arising out of the application or use of this document or any product described herein; neither does Diodes Incorporated convey any license under its patent or trademark rights, nor the rights of others. Any Customer or user of this document or products described herein in such applications shall assume all risks of such use and will agree to hold Diodes Incorporated and all the companies whose products are represented on Diodes Incorporated website, harmless against all damages.

Diodes Incorporated does not warrant or accept any liability whatsoever in respect of any products purchased through unauthorized sales channels. Should Customers purchase or use Diodes Incorporated products for any unintended or unauthorized application, Customers shall indemnify and hold Diodes Incorporated and its representatives harmless against all claims, damages, expenses, and attorney fees arising out of, directly or indirectly, any claim of personal injury or death associated with such unintended or unauthorized application.

Products described herein may be covered by one or more United States, international or foreign patents pending. Product names and markings noted herein may also be covered by one or more United States, international or foreign trademarks.

LIFE SUPPORT

Diodes Incorporated products are specifically not authorized for use as critical components in life support devices or systems without the express written approval of the Chief Executive Officer of Diodes Incorporated. As used herein:

A. Life support devices or systems are devices or systems which:

1. are intended to implant into the body, or
2. support or sustain life and whose failure to perform when properly used in accordance with instructions for use provided in the labeling can be reasonably expected to result in significant injury to the user.

B. A critical component is any component in a life support device or system whose failure to perform can be reasonably be expected to cause the failure of the life support device or to affect its safety or effectiveness.

Customers represent that they have all necessary expertise in the safety and regulatory ramifications of their life support devices or systems, and acknowledge and agree that they are solely responsible for all legal, regulatory and safety-related requirements concerning their products and any use of Diodes Incorporated products in such safety-critical, life support devices or systems, notwithstanding any devices- or systems-related information or support that may be provided by Diodes Incorporated. Further, Customers must fully indemnify Diodes Incorporated and its representatives against any damages arising out of the use of Diodes Incorporated products in such safety-critical, life support devices or systems.

Copyright © 2009, Diodes Incorporated

www.diodes.com

Sales offices**The Americas**

3050 E. Hillcrest Drive
Westlake Village,
CA 91362-3154
Tel: (+1) 805 446 4800
Fax: (+1) 805 446 4850

Europe

Kustermannpark
Balanstraße 59,
D-81541 München
Germany
Tel: (+49) 894 549 490
Fax: (+49) 894 549 4949

Taiwan

7F, No. 50,
Min Chuan Road
Hsin-Tien
Taipei, Taiwan
Tel: (+886) 289 146 000
Fax: (+886) 289 146 639

Shanghai

Rm. 606, No.1158
Changning Road
Shanghai, China
Tel: (+86) 215 241 4882
Fax (+86) 215 241 4891

Shenzhen

Room A1103-04,
ANLIAN Plaza, #4018
Jintian Road
Futian CBD,
Shenzhen, China
Tel: (+86) 755 882 849 88
Fax: (+86) 755 882 849 99

Korea

6 Floor, Changhwa B/D,
1005-5 Yeongtong-dong,
Yeongtong-gu, Suwon-si,
Gyeonggi-do, Korea 443-813
Tel: (+82) 312 731 884
Fax: (+82) 312 731 885