

STANDARD PRODUCT LABEL

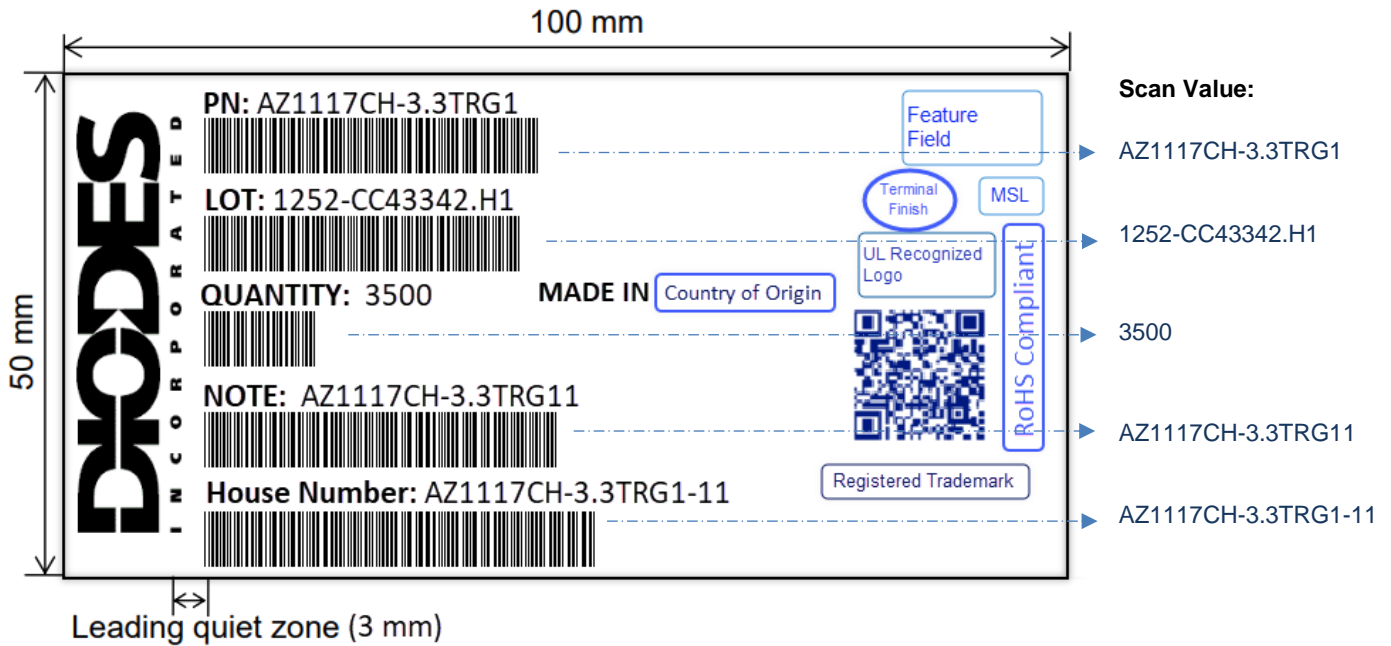

Fig. 1: Standard Product Label







**2D QR Code Scan Value:**

{ASCII28}\*PAZ1117CH-3.3TRG1-11\*1PAZ1117CH-3.3TRG11\*2PAZ1117CH-3.3TRG1\*T1252-CC43342.H1\*Q3500\*TQ3500\*1B

**Notes:**

1. 2D code (QR Code) is optional
2. Deviation from the standard format and size may be allowed if justified and approved by Diodes Corporate.
3. Diodes logo minimum size is 35 \* 6 mm

## STANDARD PRODUCT LABEL DEFINITIONS

PRODUCT LABEL TITLE FIELD FORMAT AND DEFINITION			
Title	Mandatory	Max Length / Format	Definition
PN	Yes	16 Digit / Alphanumeric	<b>[External Part Number]</b> Part number consists of generic device number followed by packaging code as assigned by Diodes Inc. Diodes inventory part number or external, orderable part number.
LOT	Yes	DC - 4 Digits (fixed) Numeric (YYWW)  LOT - 13 Digits (maximum) Alphanumeric (Factory site code suffix after "." separator)	<b>[Lot Number]</b> Traceability number (in the format of Date Code - Lot Number) assigned by the factory to identify a unique group of entities (shall contain or be able to track information such as wafer, wafer lot, operator, equipment, shift and etc.). Individual manufacturing plant format of lot number is acceptable.
QUANTITY	Yes	6 Digit / Alphanumeric	<b>[Quantity]</b> Unit packing (box/carton) quantity.
NOTE	Optional	Alphanumeric	<b>[Remark]</b> Manufacturing site may define their own.
House Number	Yes	Alphanumeric	<b>[Internal Part Number]</b> Internal manufacturing Part Number. Diodes inventory part number.
MADE IN (Country of origin)	Yes	Capital Letters	<b>[COO]</b> Country of Origin ("Country of Origin")
Feature field	Optional		Based on item attribute: <Environmental compliance> value  Lead-Free Finish.
			Totally Lead-Free Product.
			Lead-Free Finish and "Green" Product.
			Totally Lead-Free and "Green" Product.
Terminal Finish	Yes		2nd Level Interconnect Indicator for package Terminal Finish. Example: x = 3 for pure tin (Sn) x = 4 for precious metal (e.g., silver (Ag), gold (Au), nickel-palladium (NiPd), nickel-palladium-gold (NiPdAu) (no tin (Sn))) For complete set of definitions refer to JEDEC J-STD-609.
RoHS Compliant	Optional	RoHS Compliant	Indicates product is RoHS Compliant as of production date
Moisture Sensitivity Level (MSL)	Optional	MSLx	Based on item attribute: <MSL> value. x = Actual Moisture Sensitivity Level
Registered Trademark	Optional		Product Registered Trademark Ex. SBR®, -PowerDI®, IntelliFET®
UL Recognized Logo	Optional		UL Recognized Component Mark

### 2D QR CODE CHARACTERISTICS

<b>2D Type</b>	GS1 QR Code
<b>Barcode Size</b>	Minimum 1.5cm x 1.5cm
<b>Start With</b>	ASCII 28 - File
<b>Separated by</b>	*



2D Prefix DFI	Mandatory	2D Column	Definition	Example
<b>P</b>	Yes	House Number	Diodes inventory item. Internal part number.	AZ1117CH-3.3TRG1-11
<b>1P</b>	Optional	Factory Item	Factory item number if different than Diodes internal part number. Ex. BCD Part Number	AZ1117CH-3.3TRG11
<b>2P</b>	Yes	PN	External part number	AZ1117CH-3.3TRG1
<b>T</b>	Yes	DC-LOT	DC-Lot number	1252-CC43342.H1
<b>Q</b>	Yes	Quantity	Unit quantity within the packaging	3500
<b>TQ</b>	Yes	Quantity	Unit quantity within the packaging	3500
<b>1B</b>	Optional	Box No.	BCD: Box No SAT: Reel ID CAT: Reel ID	

**DFI** = Data Field Identifier

**QR Code Scan Value:**

{ASCII28}\*PAZ1117CH-3.3TRG1-11\*1PAZ1117CH-3.3TRG11\*2PAZ1117CH-3.3TRG1\*T1252-CC43342.H1\*Q3500\*TQ3500\*1B

Examples of Product Labels



Fig. 2: Standard Label for a “Green” and Lead-Free Finish, RoHS compliant with Tin terminal finish and Moisture Sensitivity Level 1.

Fig. 3: Standard Label for SBR® Product that has Lead-Free Finish and is RoHS Compliant with Tin terminal finish. Moisture Sensitivity Level 1.



Fig. 4: Standard Label for a UL recognized “Green” product, totally Lead-Free & fully RoHS Compliant with Tin terminal finish and Moisture Sensitivity Level 1.

Fig. 5: Standard Label for a totally Lead-Free product, RoHS Compliant Product with Tin terminal finish and Moisture Sensitivity Level 1.

**Diodes Vendor Carton / PO Label**

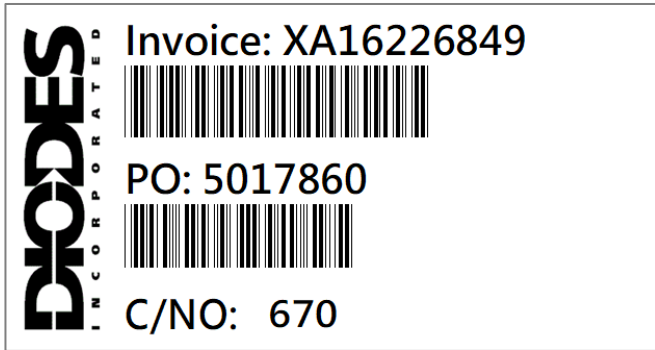

Fig. 6:

**Label Size :**

Minimum: 60 mm (W) x 40 mm (H)

Title	Definition
Invoice	Mandatory
PO	Mandatory for PO Optional for Internal shipment
C/NO	Carton Number

## STANDARD PRODUCT LABEL LOGO



Fig. 7: Diodes Logo

Title	Word "DIODES" (only)	Logo with "INCORPORATED"
Color Palette1	Blue PMS# 294	PMS# 294 ("DIODES" in Blue)/ PMS# 418 ("INCORPORATED" in Grey)
4 Color Process Equivalents (%)	C-100, M-56, Y-0, K-18	"DIODES": C-100, M-56, Y-0, K-18 "INCORPORATED": C-0, M-0, Y-30, K-79
Width/Heights Ratio2	W/H1 = 5.12	W/H2 = 4.14

Notes:

1. Diodes logo may also be reproduced in one color. The only acceptable colors for one color usage are Black or PMS# 418 Warm Grey.
2. Ratio must be maintained when resizing.

## STANDARD PRODUCT LABEL BAR CODE

LINEAR BAR CODE CHARACTERISTICS	
X Dimension (width of the narrow lines)	Not less than 9 mils.
Symbology	Code 128
Height	0.225 Inch / 0.690 Inch (for PO Label)
Density	18 or less characters per inch
Ratio	2.0 / 3.0 (for PO Label)
Print Quality	Bar code print quality should be checked periodically. Print quality shall be in accordance with ANSI X3.182-1009, Bar Code Quality Guideline.
Data Characters	43 characters (0 to 9, A to Z, -, ., /, +, %, \$ and space)
Human Readable Character Height	0.165 inch (Normal) - Title
	0.263 inch (Normal) - PO Label
	0.165 inch (Bold) - Field

Notes:

1. Product labels must have all the information fields listed above.
2. Labels may be printed by any means or technology including, but not limited to, direct transfer, thermal transfer, laser or ink jet printing.
3. Logo and all printing in black only. Diodes Inc. logo artwork available upon request.

## ESD SENSITIVE PRODUCT WARNING LABEL



**Fig. 8:** Package Label  
(Reel Label where space permits)



**Fig. 9:** Reel Label for restricted space

Note: Reels with "ESD Sensitive" embossed or molded in may not require additional ESD warning label.

## CALIFORNIA PROPOSITION 65 WARNING LABEL

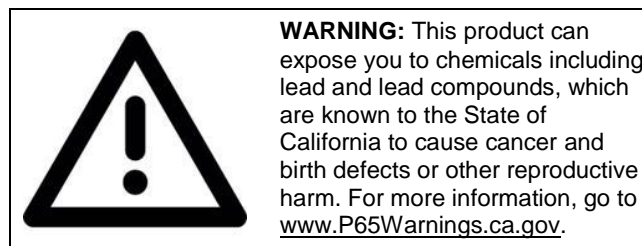

**Fig. 10:** California Proposition 65 Warning Label

Note: For products sold into California, the above label or similar, shall be affixed on product packing.

### LABEL PLACEMENT

1. All product labels must be placed per this specification.
2. 7" reels require a Bar Code label only unless ESD Sensitive.
3. Label placement for 7" and 13" reels is per Figure 11 [7" and 13" Reel Label Placement] of this specification.
4. Label placement for Ammo Packs is per Figure 12 [Ammo Pack Label Placement] of this specification.
5. Bar Code Product Labels must be affixed to all product reels, trays, ammo packs, and inner boxes.
6. Vendor Carton/PO Labels must be affixed to all outer boxes in the designated area (see AP02005 for label placement).
7. ESD Sensitive Warning labels shall be affixed to all product reels, trays, ammo packs, and inner boxes unless "ESD Sensitive" is already printed or embossed onto packing and shipping containers.
  - a. If there is no inner box the "ESD Sensitive" indicator shall be placed onto the outer carton.
8. Products shall be periodically inspected for conformance to this specification.



## 7" AND 13" REEL LABEL PLACEMENT

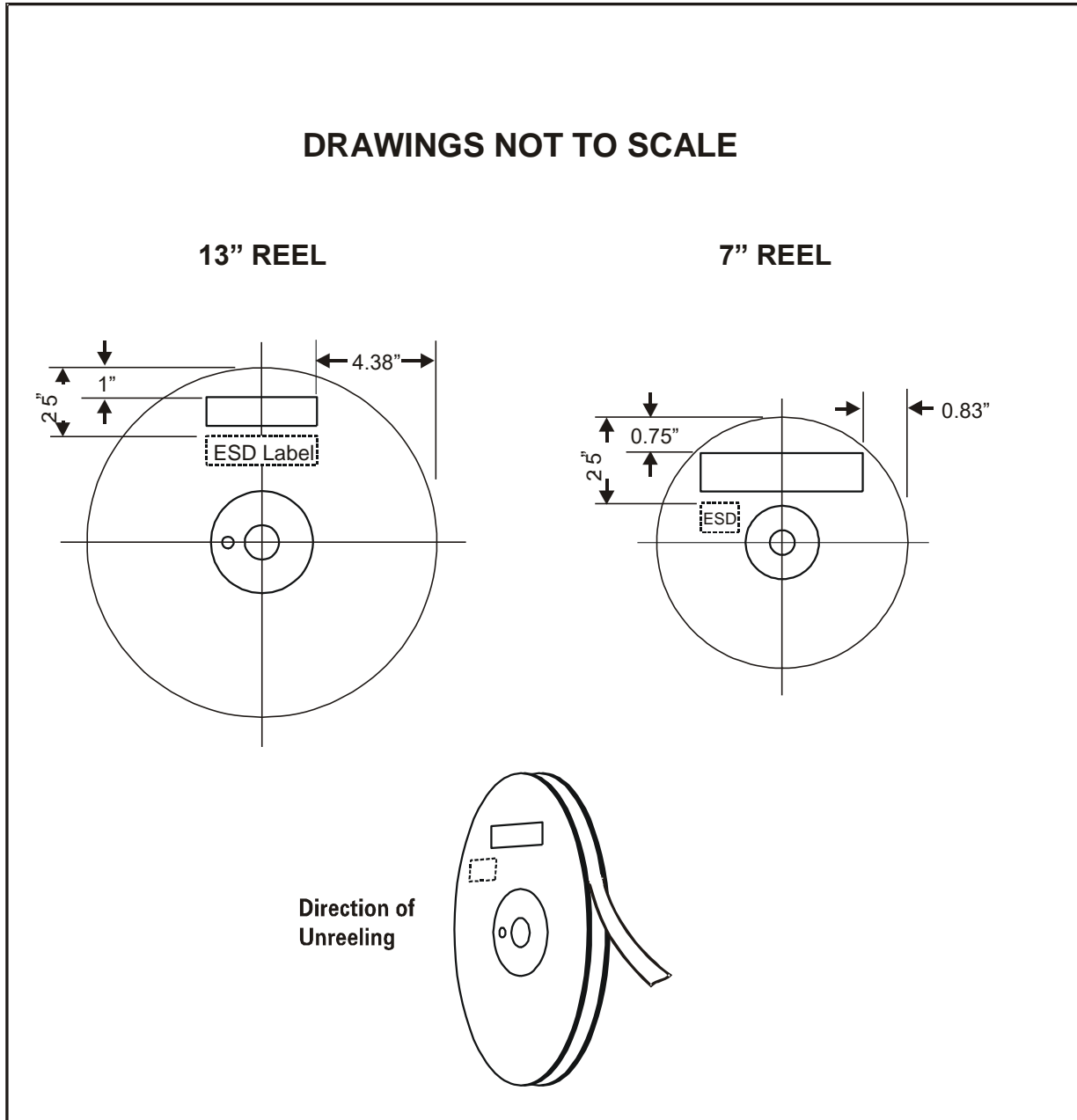

**Fig. 11: 7" and 13" Reels**

1. All Bar Code product labels must be clearly legible and shall be placed per this specification.
2. Labels shall be affixed to the top section of each reel. Text shall be human readable.
3. All reels shall include a Bar Code label.

## AMMO PACK LABEL PLACEMENT

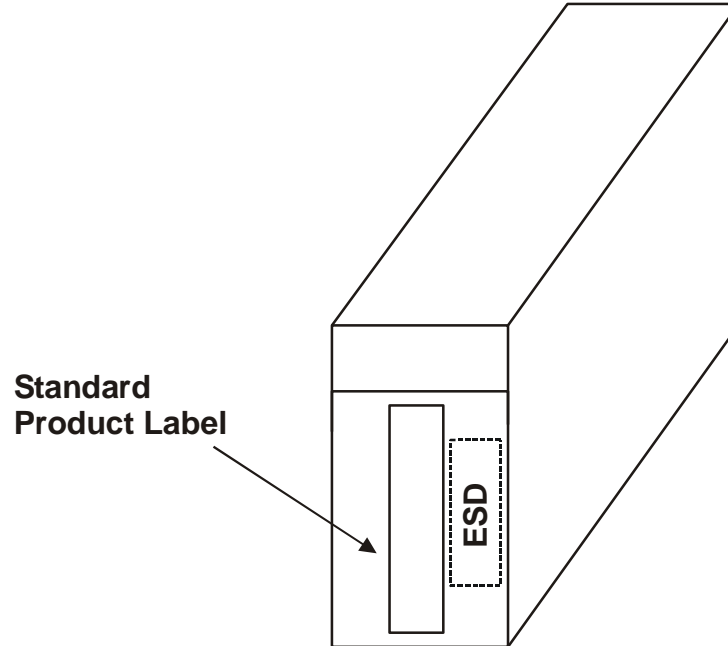

**Fig. 12:** Ammo Pack

1. Bar Code Labels shall be affixed to the top of the ammo pack, about 1" from the edge of the carton on the front.
2. Labels will be centered between carton edges and may NOT cover carton openings.
3. Top of readable text shall be toward left side of carton.