

Description

The AP65403 is a 750kHz switching frequency external compensated synchronous DC/DC buck converter. It has integrated low $R_{DS(ON)}$ high and low side MOSFETs.

The AP65403 enables continuous load current of up to 4A with efficiency as high as 96%.

The AP65403 implements an automatic custom light load efficiency improvement algorithm.

The AP65403 features current mode control operation, which enables fast transient response times and easy loop stabilization.

The AP65403 simplifies board layout and reduces space requirements with its high level of integration and minimal need for external components, making it ideal for distributed power architectures.

The AP65403 is RoHS compliant and available in a standard Green SO-8EP package.

- Gaming Consoles
- Flat Screen TV Sets and Monitors
- Set Top Boxes
- Distributed Power Systems
- Green Electronics
- Home Audio
- Consumer Electronics
- Network Systems
- FPGA, DSP and ASIC Supplies

Performance Spec of AP65403EV1

Parameter	Conditions	Performance Value
Input Voltage	4.75V to 17V Range	12V
Output Current		4A
Output Voltage		3.3V
Output Voltage Ripple		30mV _{P-P}
Switching Frequency		750kHz
Efficiency		96%

Figure 1. Evaluation Board

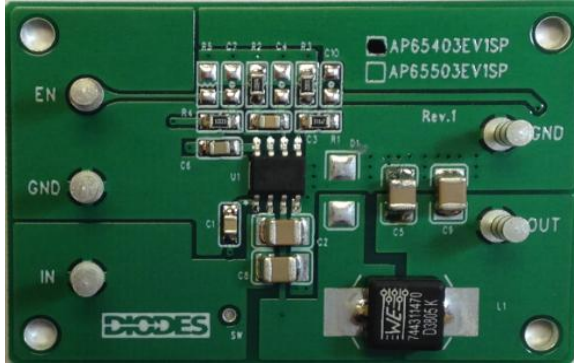
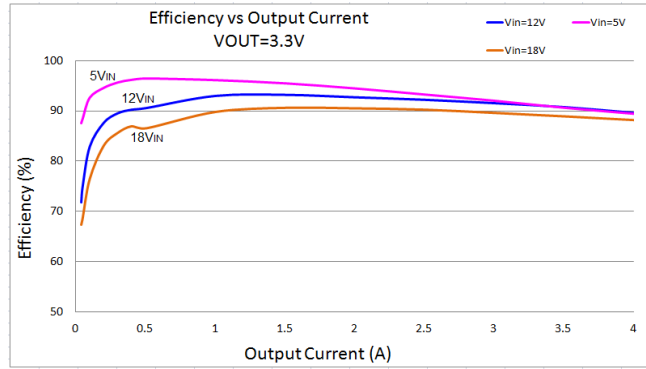
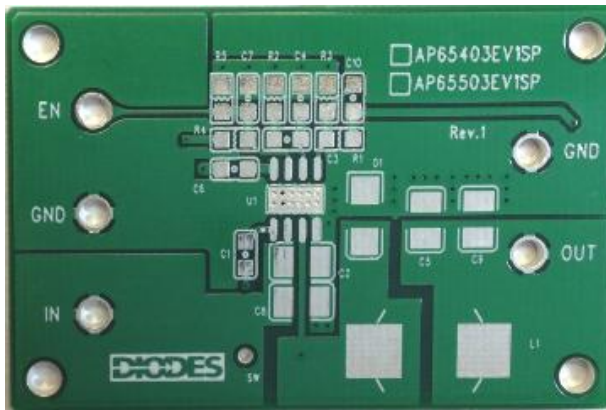

Figure 2. Efficiency vs Output Current



PCB Layouts



Top Layer

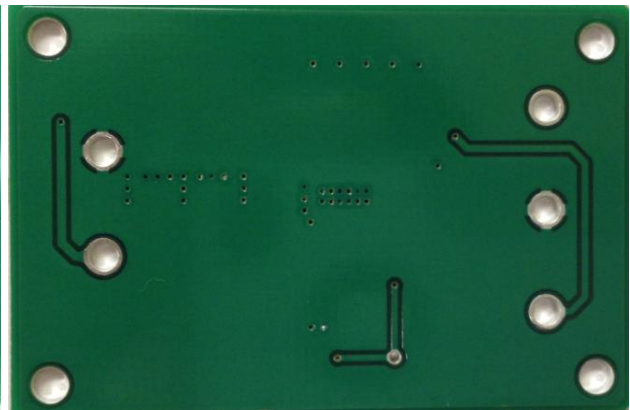

Bottom Layer

Quick Start Guide

The AP65403EV1 has a simple layout and allows access to the appropriate signals through test points. To evaluate the performance of the AP65403, follow the procedure below:

1. Connect a power supply to the input terminals V_{IN} and GND. Set V_{IN} to 12V.
2. Connect the positive terminal of the electronic load to V_{OUT} and negative terminal to GND.
3. EN has a positive voltage through a 100K pull-up to V_{IN} . No supply input is required for EN. Note: To use the EN function drive EN above 1.3V to start the converter and below 0.4V to stop the converter.
4. The evaluation board should now power up with a 3.3V output voltage.
5. Check for the proper output voltage of 3.3V ($\pm 1\%$) at the output terminals V_{OUT} and GND. Measurement can also be done with a multimeter with the positive and negative leads between V_{OUT} and GND.
6. Set the load to 4A through the electronic load. Check for the stable operation of the SW signal on the oscilloscope. Measure the switching frequency. A test point is conveniently located at the head of the inductor.

Measurement/Performance Guidelines:

- 1) When measuring the output voltage ripple, maintain the shortest possible ground lengths on the oscilloscope probe. Long ground leads can erroneously inject high frequency noise into the measured ripple.
- 2) For efficiency measurements, connect an ammeter in series with the input supply to measure the input current. Connect an electronic load to the output for output current.

EVALUATION BOARD SCHEMATIC

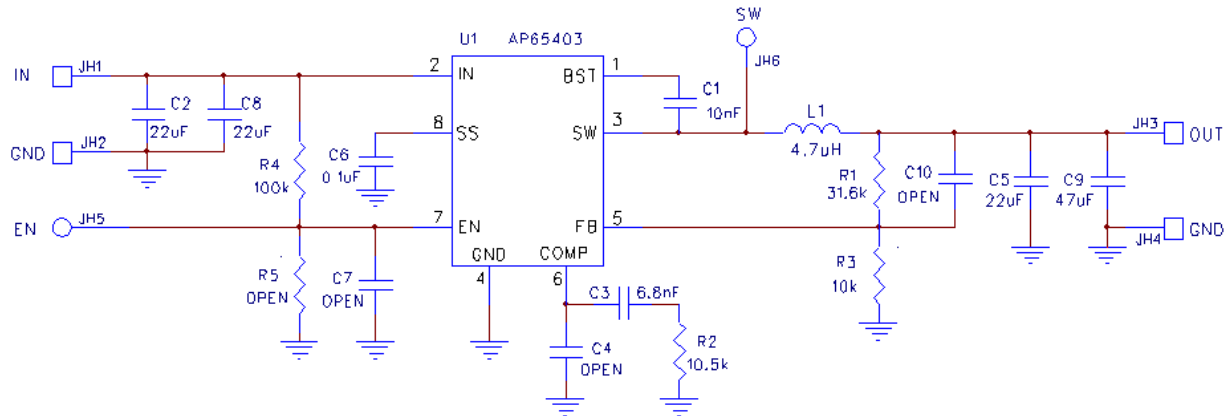

BILL OF MATERIALS

REF	VALUE	DESCRIPTION	PACKAGE	MANUFACTURER	MANUFACTURER P/N
C1	10nF	Ceramic Capacitor, 50V, X7R	0805	AVX	08055C103KAT2A
C2, C5, C8	22μF	Ceramic Cap, 25V, X5R	1210	AVX	1210YD226KAT2A
C3	6.8nF	Ceramic Cap, 50V, X7R	0805	AVX	08055C682KAT2A
C6	0.1μF	Ceramic Cap, 50V, X7R	0805	AVX	08055C104KAT2A
C9	47μF	Ceramic Capacitor, 16V, X5R	1210	AVX	GRM32ER61C476KE15K
L1	4.7μH	Inductor	SMD	Würth Electronics	744311470
R1	31.6kΩ	Resistor, 1%	0805	Panasonic	ERJ-6ENF3162V
R2	10.5kΩ	Resistor, 1%	0805	Panasonic	ERJ-6ENF1052V
R3	10.0kΩ	Resistor, 1%	0805	Panasonic	ERJ-6ENF1002V
R4	100kΩ	Resistor, 1%	0805	Panasonic	ERJ-6ENF1003V
U1		DC/DC Converter	SO-8EP	Diodes Inc	AP65403SP

IMPORTANT NOTICE

DIODES INCORPORATED MAKES NO WARRANTY OF ANY KIND, EXPRESS OR IMPLIED, WITH REGARDS TO THIS DOCUMENT, INCLUDING, BUT NOT LIMITED TO, THE IMPLIED WARRANTIES OF MERCHANTABILITY AND FITNESS FOR A PARTICULAR PURPOSE (AND THEIR EQUIVALENTS UNDER THE LAWS OF ANY JURISDICTION).

Diodes Incorporated and its subsidiaries reserve the right to make modifications, enhancements, improvements, corrections or other changes without further notice to this document and any product described herein. Diodes Incorporated does not assume any liability arising out of the application or use of this document or any product described herein; neither does Diodes Incorporated convey any license under its patent or trademark rights, nor the rights of others. Any Customer or user of this document or products described herein in such applications shall assume all risks of such use and will agree to hold Diodes Incorporated and all the companies whose products are represented on Diodes Incorporated website, harmless against all damages.

Diodes Incorporated does not warrant or accept any liability whatsoever in respect of any products purchased through unauthorized sales channel.

Should Customers purchase or use Diodes Incorporated products for any unintended or unauthorized application, Customers shall indemnify and hold Diodes Incorporated and its representatives harmless against all claims, damages, expenses, and attorney fees arising out of, directly or indirectly, any claim of personal injury or death associated with such unintended or unauthorized application.

Products described herein may be covered by one or more United States, international or foreign patents pending. Product names and markings noted herein may also be covered by one or more United States, international or foreign trademarks.

This document is written in English but may be translated into multiple languages for reference. Only the English version of this document is the final and determinative format released by Diodes Incorporated.

LIFE SUPPORT

Diodes Incorporated products are specifically not authorized for use as critical components in life support devices or systems without the express written approval of the Chief Executive Officer of Diodes Incorporated. As used herein:

A. Life support devices or systems are devices or systems which:

1. are intended to implant into the body, or
2. support or sustain life and whose failure to perform when properly used in accordance with instructions for use provided in the labeling can be reasonably expected to result in significant injury to the user.

B. A critical component is any component in a life support device or system whose failure to perform can be reasonably expected to cause the failure of the life support device or to affect its safety or effectiveness.

Customers represent that they have all necessary expertise in the safety and regulatory ramifications of their life support devices or systems, and acknowledge and agree that they are solely responsible for all legal, regulatory and safety-related requirements concerning their products and any use of Diodes Incorporated products in such safety-critical, life support devices or systems, notwithstanding any devices- or systems-related information or support that may be provided by Diodes Incorporated. Further, Customers must fully indemnify Diodes Incorporated and its representatives against any damages arising out of the use of Diodes Incorporated products in such safety-critical, life support devices or systems.

Copyright © 2014, Diodes Incorporated

www.diodes.com