

AN56

12Vac LED Driving without smoothing capacitors

Dr. Kit Latham, Senior Applications Engineer, Diodes Incorporated

Introduction

LED based architectural lighting is now coming of age, but there are still some problems to be considered when designing luminaires to be fitted into existing installations.

This Application Note discusses some of the challenges and shows that the omission of the traditional smoothing capacitors has advantages in saving cost, space and PFC problems.

Dimming will be discussed in a forthcoming note.

Description

This application note describes driver solutions developed using the Zetex ZXLD1360 LED driver IC to drive a series of LEDs from 12Vac transformers. The solutions take advantage of the Super Barrier Rectifier SBR2A40P1. This device has 2A 40V capability and high thermal stability. It is housed in the proprietary PowerDI123 package, which offers a combination of small size and good thermal conductivity.

Existing transformers

Ideally a LED based bulb should fit into existing sockets and be satisfactorily driven from the existing 12V transformer. These are usually electronic transformers that produce a 30-40kHz square wave modulated to >100% at 100Hz or 120Hz. They are designed to drive halogen bulbs, which are resistive loads at power levels of 20 to 50W. Many of them will not properly drive a load much less than 20W and most LED lamps are about 7W. Sometimes this problem can be solved by driving more than one LED unit from each transformer.

AN56

Characteristics of an LED lamp.

An LED differs from a halogen in many ways. Firstly it is polarity sensitive, secondly it's IV curve is very different from a halogen bulb and the way its lumen output varies with current even more so. The Figures 1 & 2 below compare a 20W halogen with a string of 3 white LEDs in series.

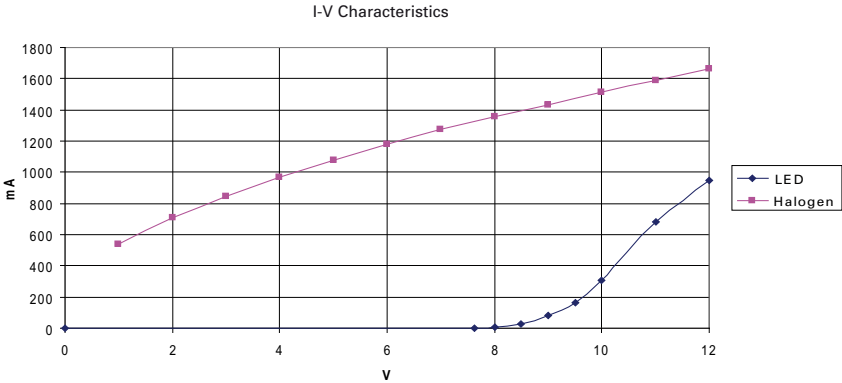

Figure 1 - Comparison of the I-V characteristics of the 2 types of lamp.

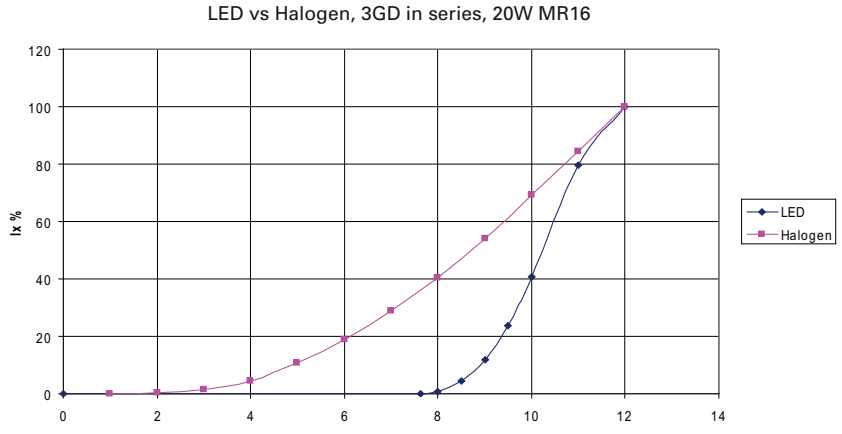

Figure 2 - Comparison of the optical output characteristics of the 2 types of lamp

Perhaps the biggest difference is in the way that they generate light. The halogen produces light as part of the spectrum of radiation generated due to the temperature of the filament. The majority of the output is in the IR region and is radiated out of the lamp in the form of IR. The low efficiency of the halogen bulb is a result of the majority of the radiation produced being outside the visible range, if the filament could survive being run at a temperature of 6300K then its output would be optimised in the visible range and the efficiency would be much higher. The visible spectrum is smooth therefore it contains all visible colours and the variation of intensity with colour is gradual. In other words, it has a high colour rendering index (CRI.) Some of the radiation is converted into heat as it strikes the materials of the bulb and has to be conducted away.

The LED is inherently a narrow band emitter, a white LED is really a blue LED with a phosphor coating which is energised by the blue light and produces a light biased towards the red end of the spectrum which, in conjunction with the original blue, makes it look white. The CRI varies from type to type, cool whites have a value of about 70%, neutral whites about 75% and warm whites about 80%. Halogens, being essentially blackbody radiators, have a CRI of 100%.

Consequently there is very little emitted IR and the energy that is not converted to light – approximately 80-85% - has to be conducted away as heat. This has a big effect on the design of the luminaire and is often the limiting factor on the brightness that is achievable in practice.

The LED should be driven at a controlled - and usually constant - current. The reason is really 2 fold. Firstly the V_f reduces as the device warms up, so thermal run-away is a danger, and secondly the characteristics and lifetime depend on the operating current being controlled.

Drive circuits

These circuits are intended to be driven from a 12Vac transformer. As we have seen the LED is polarity sensitive and the halogen is not, so the existing fittings are designed for bulbs that can be fitted either way round.

The driver will therefore need a bridge rectifier and this will reduce the achievable efficiency due to the voltage drop across the bridge.

Losses in the bridge and the other circuit components increase with increasing load current and for this reason higher efficiency is achievable using a series string of LEDs rather than a parallel array. The series string also has the advantage that the current is the same in each die.

However many manufacturers are producing led arrays that are inherently parallel mainly due to the use of one large die rather than several smaller ones but also because it eases the thermal design of the LED module.

A 12Vac drive has a peak voltage of 17V and if we allow for the transformer output being 20% higher either due to tolerance in the manufacture or the mains voltage or because it is lightly loaded, then we need to allow for at least 20Vpeak. If the bridge has a small capacitor then the output will be approximately the same whether driven from a magnetic 50/60Hz transformer or an electronic one.

Smoothing capacitor

Conventionally a rectifier bridge is followed by a smoothing capacitor intended to reduce the ripple voltage from the bridge.

If we want to drive a LED array at 1A and we can accept a voltage droop of 1V then the required value of capacitor is approximately 5000uF. Such a capacitor is large, expensive and will have a lifetime of a few thousand hours at best. It may also mean that power factor correction (PFC) is required. The LEDs and driver will be capable of 50 thousand hours if properly driven.

It is not essential to use a large capacitor, the LED can be driven from the unsmoothed waveform but the result will be a light output with a 100Hz modulation. PFC will not be needed.

AN56

Driving 3 700mA LEDs in series

Fig 3 shows a circuit diagram of an arrangement capable of driving 700mA average into 3 LEDs in series from a 12Vac source.

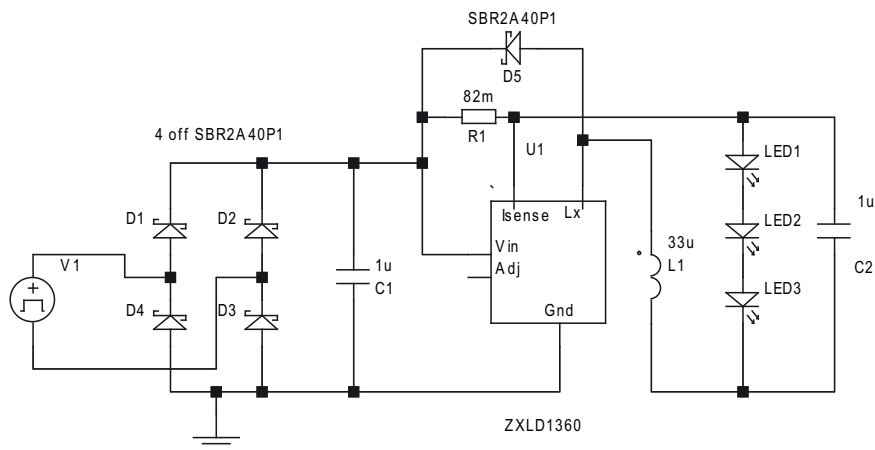

Figure 3 - Circuit diagram of a 12Vac LED driver circuit

The Figure 4 shows a simulation of the performance using the free Zetex simulator available from www.diodes.com.

Bill of materials

Ref	Value	Package	Part No	Manufacturer	Comments
D1-5	40V,2A	PowerDI [®] 123	SBR2A40P1	Diodes	
LED1-3	white		generic		see text
U1	ZXLD1360	TSOT23-5	ZXLD1360E5TA	Zetex	
C1,2	1µF 50V	1206	NMC1206X7R105K50F	NIC	
L1	33µH	MSS1038	MSS1038-333	CoilCraft	
R1	82mR	1206	generic		see text

Table 1 - Bill of materials

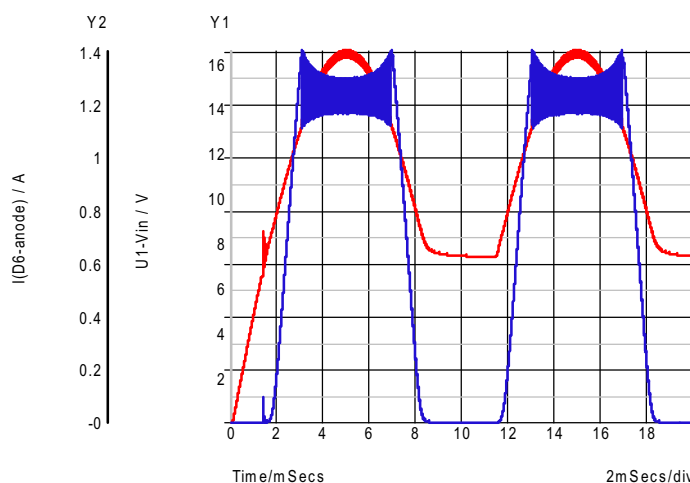

Figure 4 - Simulated performance of the circuit in Figure 3

The LED current is 660mA average and about 1.4A peak and there are only inexpensive ceramic capacitors used. The voltage curve is taken just after the bridge and the current curve is the LED current.

The ZXLD1360 is a 30V part so there is plenty of safety margin in the voltage. The bridge consists of Super Barrier SBR2A40P1 devices which are conservatively rated in the design and are offered in small packages.

In order to verify the simulated performance the design has been built and the results are shown in the table and scope plots below. It should be noted that accurate measurements of these LED current waveforms are difficult due to the nature of the waveform and also because they depend on the temperature of the LED when the supply voltage is not greater than the V_f of the LED array.

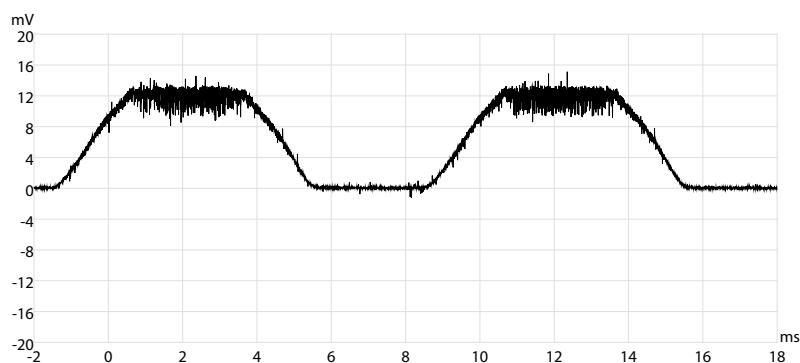

Figure 5 - 3 LEDs in series, the Y axis is mV over a 100mR current sampling resistor

The current is controlled at 1200mA as determined by the 82mR resistor R1. The average current was measured at 630mA in this case.

AN56

If a string of 2 LEDs is driven then the duty cycle is longer as the V_f of the 2 LEDs is lower, as shown in Fig 6.

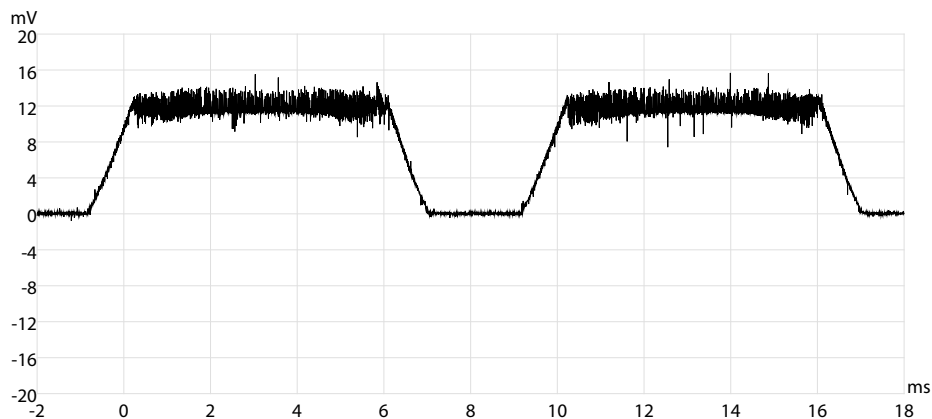

Figure 6 - 2 LEDs in series, current sampling as Figure 5

In this case the average current was measured to be 802mA.

And for a single LED the result is shown in Fig 7.

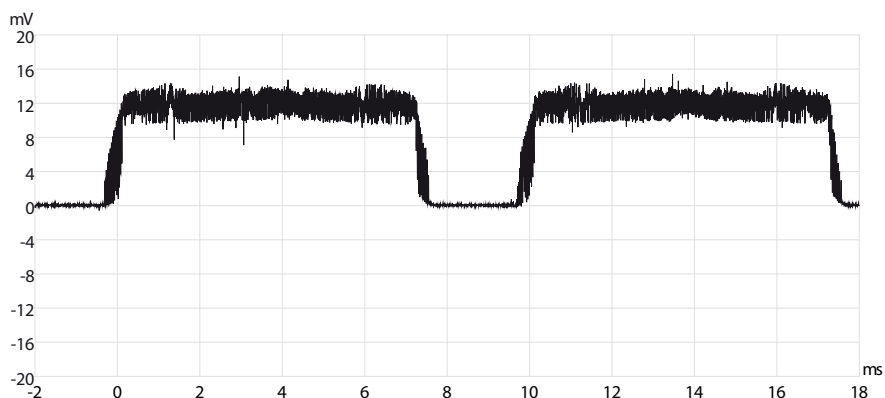

Figure 7 - A single LED, current sampling as Figure 5

Here the average current was measured to be 884mA.

The current over the flat area of the waveform is controlled by the value of R_1 , which sets the current at which the circuit is controlled at when the full wave rectified input is greater than the V_f of the LED string.

The effect of a smoothing capacitor

The problems with smoothing were discussed above now the effect of a realistic capacitor is considered. About the best that can be done in terms of size and reasonable cost is 2 150uF 20V tantalum capacitors. The results are shown below.

Fig 8 shows a string of 3 LEDs the waveform is not very different from Figure 5.

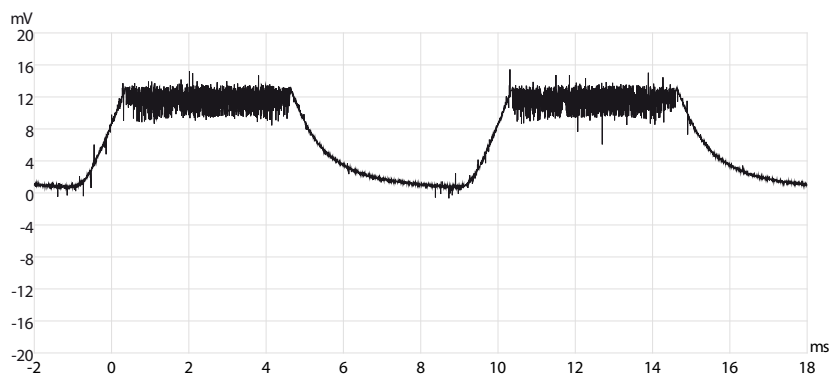

Figure 8 - 3 LEDs with a 300uF smoothing capacitor. Current sampling as Figure 5.

And the average current was measured as 700mA.

For a string of 2 the result is shown in Figure 9:

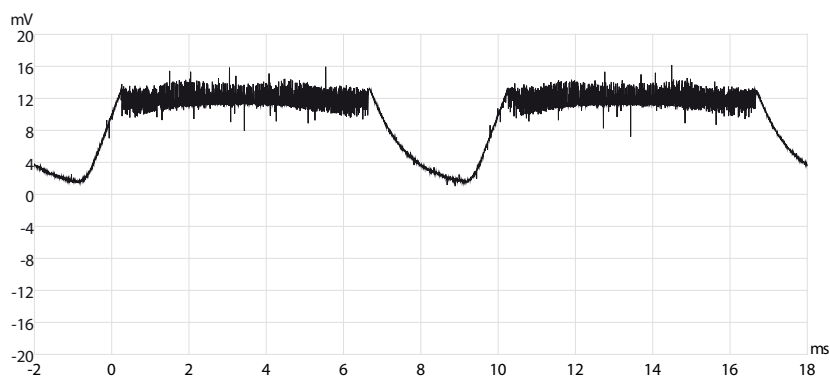

Figure 9 - 2 LEDs with 300uF smoothing capacitor. Current sampling as Figure 5

The average current was 935mA.

AN56

Finally for a single led the result was a smooth DC, as shown in Fig 10.

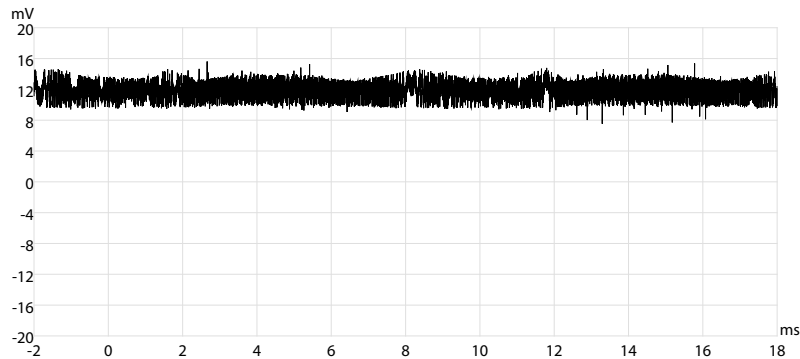

Figure 10 - A single LED with 300uF smoothing capacitor. Current sampling as Fig 5

This time the current was 1177mA – too high for the ZXLD1360.

These results are summarised in the Table 2 below.

		No Capacitor		300uF Capacitor	
LEDs	Vin	I in av	I LED av	I in av	I LED av
1x1	12ac	399	884	538	1177
1x2	12ac	588	802	712	935
1x3	12ac	579	630	632	700

Table 2 - Summary of Results

In all cases the LEDs were Cree but high power white LEDs are electrically very similar so the circuit will work with other types.

100Hz optical modulation

The circuits described above result in LED current modulation at 100Hz and this means a light output that is also modulated at 100Hz.

Does it matter?

There is no discernable flicker at 100Hz and there will be no beat frequencies between several luminaires in one room as the modulation is synchronised to the mains for all of them. Many fluorescent tubes have significant modulation at 100Hz and these do not cause problems (when operating properly).

Photo sensitive epilepsy is generally accepted to be triggered only by frequencies below 60Hz and usually below 25Hz, and this is reflected in the guidelines for TV broadcast. Video photography and other movement sensitive operations may be affected in much the same way as they can be affected by fluorescent lamps.

So in normal circumstances there is little reason to expect problems.

Thermal matters

The dissipation of the heat is usually a major factor in the design of a LED based luminaire. The principal source of heat is the LEDs and their positioning relative to the driver circuit is important. Ideally the heat from the LEDs should be conducted to ambient in a path that does not intersect with the driver circuit. In reality this is seldom practical and the thermal design affects the whole system.

The dissipation in the driver has 2 components, the DC 'on' resistance of the internal switch and the switching losses in that switch. Switching losses normally dominates and can be mitigated by reducing the switching frequency. A value of around 100kHz is normally optimum from this perspective but does involve a physically larger and potentially more expensive inductor.

There is also dissipation in the diodes, both bridge and flywheel, and this can be minimised by selecting a device with low V_f and reverse leakage. SBRs were selected because of their superior thermal performance.

Finally the design of the pcb is also very important and IMS is often used to offer a low thermal impedance from the devices to the heat sink or casing. If this is not practical then the use of thermal vias significantly improves thermal conductivity.

Choice of components and BoMs

The ZXLD1360 data sheet contains details regarding the choice of components and should be read in conjunction with this section.

Referring to the circuit diagram Fig 1, the components were chosen as follows.

Firstly the desired average LED current is established, this is often limited by thermal dissipation and the thermal design of the luminaire. From the circuit design perspective the details of the LED array are not important, only the voltage and current of the array matter. However if a parallel arrangement is contemplated the current sharing needs to be considered.

The peak voltage from the transformer may go up to 20V, so a 30V device has ample margin. The ZXLD1360 is a 30V device rated for an average current of 1A and is available in a SOT23-5 package.

The selection of the rectifier diodes is important particularly if strings of 3 LEDs are required. The specified SBR2A40P1 have excellent V_f characteristics and are available in small package. The V_f is important not only for efficiency and dissipation but also to prevent lack of voltage headroom limiting the achievable LED current.

The low V_f with good thermal performance also makes the device a good choice for the freewheeling diode D5.

AN56

R1 is chosen to set the current at which the circuit controls, 100mR results in 1A and the controlled current is inversely proportional to the value of this resistor. The average current is not inversely proportional if running from a non smoothed source, as is shown in Fig11.

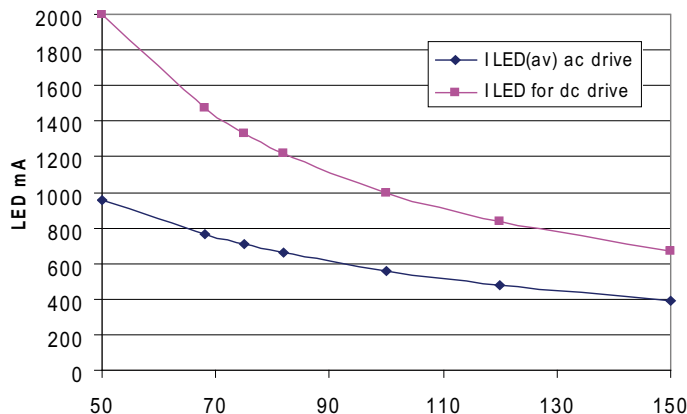

Figure 11 - Comparison between dc and ac drive for 3 LEDs in series.

The ac drive curve is derived from the simulator and assumes there is no significant smoothing capacitor. The dc curve is the value that would apply if the circuit were driven by dc and would also apply if there were a large smoothing capacitor. These values also apply to the controlled (flat) part of the current waveform in the ac case.

The comparison is for a string of 3 LEDs and the difference will be less for fewer LEDs as the lower Vf means that the current will be controlled for a larger percentage of the cycle (see the waveforms above).

The dissipation within the resistor is I^2R so at 1A /100mR we get 100mW and an 0805 component would normally be adequate but if temperature is a challenge then a 1206 may be preferable.

The choice of inductor is not critical, but there are a few considerations in its choice. It must have a saturation current well above the operating current (particularly if the saturation current is specified at 50% reduction) and reasonably low series resistance. The inductor is usually required to be small and inexpensive and these considerations together might lead to the choice of a very small value of inductance. The value affects the operating frequency and if the frequency is too high the driver losses and temperature increase. If the housing temperature is likely to be high it is sometimes worth increasing the inductance to reduce the dissipation in the driver.

For a quick and easy way to check component values, see the calculator and simulator available from www.zetex.com or www.diodes.com

Buck-Boost designs

Driving 3 white LEDs in series from 12Vac without a smoothing capacitor means that the LED average current is about 53% of the controlled current. Using a buck-boost design could increase this ratio by boosting the current in the area of the cycle where the input voltage is less than the Vf of the LED string. In practice the added cost and complexity is often not worth the gains achieved.

Luminance comparison

Three modern white LEDs driven at 700mA can give a luminous output of 450lm each, 1350 together, and these figures are constantly improving. Quartz halogen lamps produce about 24lm/W so a 20 W bulb would be expected to produce about 900lm.

Acoustic noise

There have been some reports of acoustic noise arising from the 100Hz. This effect has not manifested itself here except using certain triac based dimmers in conjunction with a circuit with no smoothing capacitor.

If acoustic noise does appear from the driver circuit then selecting a different inductor will usually solve the problem.

Conclusion

Various options for driving LED arrays from a 12Vac transformer have been discussed and some detailed.

It has been shown that the omission of the traditional smoothing capacitor can save cost, space and PFC problems and that the resultant 100Hz or 120Hz modulation causes no problems in most applications.

It is possible that the modulation could cause problems in some situations and this would need to be tested before large scale deployment in a specific situation.

AN56

Definitions

Product change

Diodes Incorporated reserves the right to alter, without notice, specifications, design, price or conditions of supply of any product or service. Customers are solely responsible for obtaining the latest relevant information before placing orders.

Applications disclaimer

The circuits in this design/application note are offered as design ideas. It is the responsibility of the user to ensure that the circuit is fit for the user's application and meets with the user's requirements. No representation or warranty is given and no liability whatsoever is assumed by Diodes Inc. with respect to the accuracy or use of such information, or infringement of patents or other intellectual property rights arising from such use or otherwise. Diodes Inc. does not assume any legal responsibility or will not be held legally liable (whether in contract, tort (including negligence), breach of statutory duty, restriction or otherwise) for any damages, loss of profit, business, contract, opportunity or consequential loss in the use of these circuit applications, under any circumstances.

Life support

Diodes Zetex products are specifically not authorized for use as critical components in life support devices or systems without the express written approval of the Chief Executive Officer of Diodes Incorporated. As used herein:

A. Life support devices or systems are devices or systems which:

1. are intended to implant into the body

or

2. support or sustain life and whose failure to perform when properly used in accordance with instructions for use provided in the labelling can be reasonably expected to result in significant injury to the user.

B. A critical component is any component in a life support device or system whose failure to perform can be reasonably expected to cause the failure of the life support device or to affect its safety or effectiveness.

Reproduction

The product specifications contained in this publication are issued to provide outline information only which (unless agreed by the company in writing) may not be used, applied or reproduced for any purpose or form part of any order or contract or be regarded as a representation relating to the products or services concerned.

Terms and Conditions

All products are sold subjects to Diodes Inc. terms and conditions of sale, and this disclaimer (save in the event of a conflict between the two when the terms of the contract shall prevail) according to region, supplied at the time of order acknowledgement.

For the latest information on technology, delivery terms and conditions and prices, please contact your nearest Diodes sales office .

Quality of product

Diodes Zetex Semiconductors Limited is an ISO 9001 and TS16949 certified semiconductor manufacturer.

To ensure quality of service and products we strongly advise the purchase of parts directly from Zetex Semiconductors or one of our regionally authorized distributors. For a complete listing of authorized distributors please visit: www.zetex.com or www.diodes.com

Diodes Zetex Semiconductors does not warrant or accept any liability whatsoever in respect of any parts purchased through unauthorized sales channels.

ESD (Electrostatic discharge)

Semiconductor devices are susceptible to damage by ESD. Suitable precautions should be taken when handling and transporting devices. The possible damage to devices depends on the circumstances of the handling and transporting, and the nature of the device. The extent of damage can vary from immediate functional or parametric malfunction to degradation of function or performance in use over time. Devices suspected of being affected should be replaced.

Green compliance

Diodes Zetex Semiconductors is committed to environmental excellence in all aspects of its operations which includes meeting or exceeding regulatory requirements with respect to the use of hazardous substances. Numerous successful programs have been implemented to reduce the use of hazardous substances and/or emissions.

All Zetex components are compliant with the RoHS directive, and through this it is supporting its customers in their compliance with WEEE and ELV directives.

Product status key:

"Preview"	Future device intended for production at some point. Samples may be available
"Active"	Product status recommended for new designs
"Last time buy (LTB)"	Device will be discontinued and last time buy period and delivery is in effect
"Not recommended for new designs"	Device is still in production to support existing designs and production
"Obsolete"	Production has been discontinued

Datasheet status key:

"Draft version"	This term denotes a very early datasheet version and contains highly provisional information, which may change in any manner without notice.
"Provisional version"	This term denotes a pre-release datasheet. It provides a clear indication of anticipated performance. However, changes to the test conditions and specifications may occur, at any time and without notice.
"Issue"	This term denotes an issued datasheet containing finalized specifications. However, changes to specifications may occur, at any time and without notice.

Diodes Zetex sales offices

Europe	Americas	Asia Pacific	Corporate Headquarters
Zetex GmbH Kustermann-park Balanstraße 59 D-81541 München Germany Telephone: (49) 89 45 49 49 0 Fax: (49) 89 45 49 49 49 europe.sales@zetex.com	Zetex Inc 700 Veterans Memorial Highway Hauppauge, NY 11788 USA Telephone: (1) 631 360 2222 Fax: (1) 631 360 8222 usa.sales@zetex.com	Diodes Zetex (Asia) Ltd 3701-04 Metroplaza Tower 1 Hing Fong Road, Kwai Fong Hong Kong Telephone: (852) 26100 611 Fax: (852) 24250 494 asia.sales@zetex.com	Diodes Incorporated 15660 N. Dallas Parkway Suite 850, Dallas TX 75248, USA Telephone: (1) 972 385 2810 www.diodes.com

© 2008 Published by Diodes Incorporated