

Design Guideline and Application Notes of AP1681 System Solution

Prepared by Wang Zhao Kun
System Engineering Dept.

1. Introduction

The AP1681 is a powerful high performance AC/DC power supply controller for dimmable LED lighting applications. The device uses Pulse Frequency Modulation (PFM) technology to regulate output current according to the wall dimmer conduct angle without opto-coupler and secondary CV/CC control circuitry.

The AP1681 achieves wide dimming range without visible flicker and is compatible with diverse dimmers.

The AP1681 features low start-up current, low operation current and high efficiency. It also has rich protection functions including over voltage, short circuit, over current and over temperature protections.

The AP1681 is available in SOIC-8 package.

2. Product Features

- Primary Side Control for Output Current Regulation Without Opto-coupler and Secondary CV/CC Control Circuitry
- Eliminates Control Loop Compensation Circuitry
- Adjustable Full Brightness and Full Dimming Setting
- Wide Dimming Range From 100% to 1%, Down to

- Full Darkness
- Adjustable Dimming Curve for Human Eye Sensitivity
- No Visible Flicker
- Connectivity with Analog / Digital / Hybrid Dimming Mode
- Built-in Acceleration Start
- Adjustable Soft-start Timing
- CV Open-load Regulation and Reload Detection
- Over Voltage and Short Circuit Protection
- Over Temperature Protection
- Over Current Protection
- Maximum Switch On-time Protection

3. Pin Configuration and Description

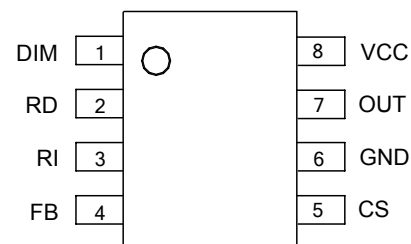

Figure 1. Pin Configuration of AP1681

Pin Number	Pin Name	Function
1	DIM	This pin is dim signal sensing pin. It senses the dimming signal and then controls output current. Output current will at maximum when DIM voltage reaches 3.5V. Usually a second order RC filter is connected between rectified AC voltage and DIM pin.
2	RD	This pin is the IC internal bias pin. There is a 1.5V reference voltage at the pin. The 1.5V voltage divide RD pin resistor will determine a bias current for the IC. Usually a 51k resistor is connected at this pin to GND.
3	RI	This pin will generate a current according to DIM pin voltage. Change the RI pin resistor will change output current dimming curve gradient. Usually a 100k to 120k resistor is connected at this pin to GND.
4	CS	The current sensing pin. The primary switch maximum current sensing threshold is 0.51V.
5	FB	This pin captures the feedback voltage from the auxiliary winding. When secondary side diode turns on, the auxiliary voltage is given by: $V_{AUX} = \frac{N_{AUX}}{N_S} \times (V_o + V_d)$, Where the V_d is the output rectify diode forward drop voltage. FB voltage is used to control no load output voltage and determine acceleration stop point at start up phase.
6	GND	Ground. Current return for gate driver and control circuits of the IC. The power ground and signal ground should be connected by one node. The ground of transformer must be separated from the ground of IC in order to pass ESD test.

Pin Number	Pin Name	Function
7	OUT	Gate driver output pin. AP1681 is designed to drive MOSFET. A series resistor between this pin and the power switch gate can reduce high frequency noise.
8	VCC	Supply pin of gate driver and control circuit of the IC.

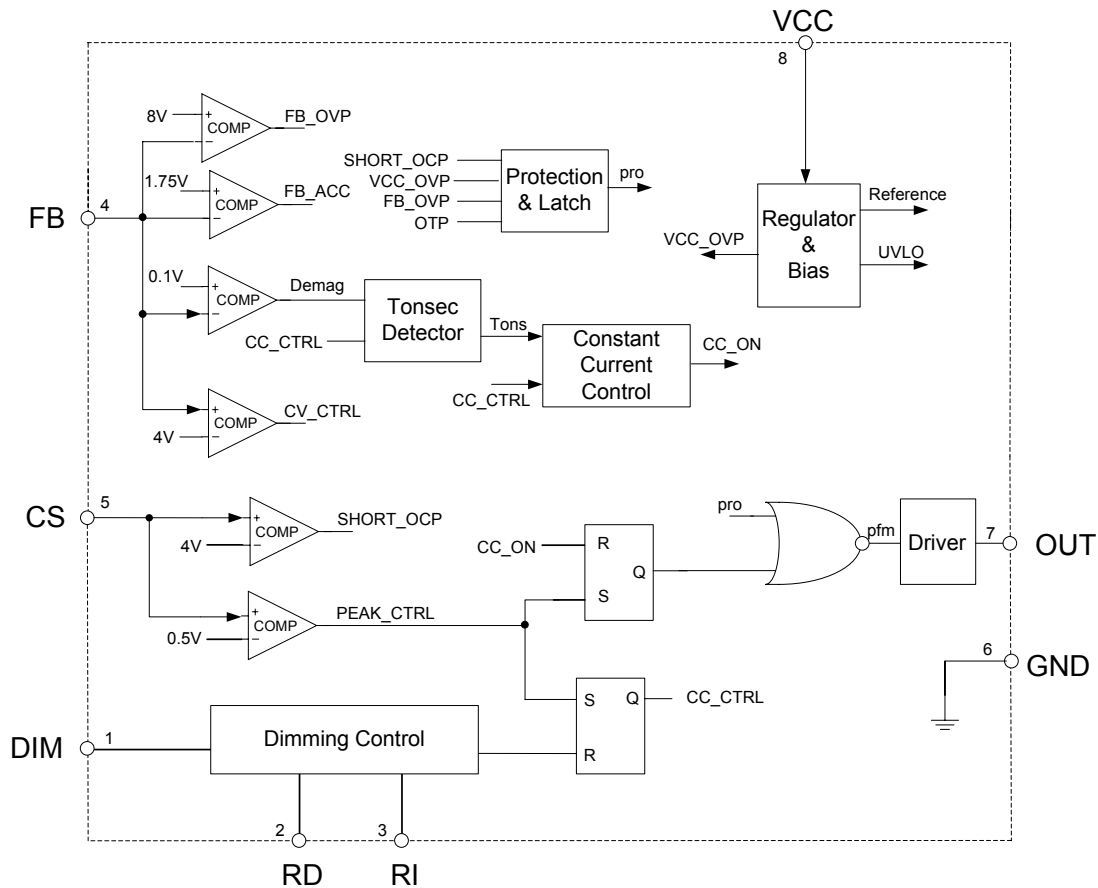

Figure 2. Functional Block Diagram of AP1681

4. Operation Principle and Design Guideline

4.1 Circuit Structure Introduction of AP1681 Application

AP1681 is a Primary Side Regulation (PSR) LED driver IC with dimming function for narrow range application. According to different requirements, the AP1681 can be applied to three types of circuit structure as Table 1.

Table 1. AP1681 Application Architecture Types

Structure Types	Single Stage	Single Stage with Valley-Fill Circuit	Two Stages with Boost
Input Voltage Range	90-132VAC or 220-264VAC	90-132VAC or 220-264VAC	90-132VAC or 220-264VAC
PF	No	Low	High
THD	Very bad	Bad	Very good
Cost	Very Low	Low	Very high

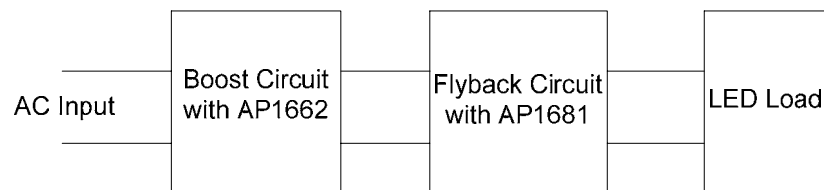

Figure 3. Block of Two Stages

For low cost application, the simple single stage structure with AP1681 is the better solution to realize dimmable LED driver. Combined with valley-fill circuit, the single stage structure can not only improve PF performance to meet basic PFC requirement, but also keep the lower cost benefit. It is noticed that a bleeding circuit is required to maintain the conduction current of dimmer switch when the conduction angle is too small. As to high end application which needs the higher PF and very low THD, it is recommended to select two stages structure with boost converter and AP1681 PSR LED driver. The AP1662 controller from BCD is a cost efficient choice for boost converter. The combined solution with AP1662 and AP1681 is a best solution for wall dimmer application to achieve the better performance: the higher PF, the lower

THD and good dimmable function. This document is based on a two stage design with AP1662 boost converter and AP1681 dimmable LED driver. The document contents focus on AP1681 design guideline and application notes, the detailed design information of AP1662 refers to the BCD relative document.

4.2 Introduction of PSR LED Driver with AP1681

Compare to Secondary Side Regulation (SSR) solution on LED driver application, PSR is very simple and low cost solution without secondary side CC control circuit, opto-coupler and even external loop compensation circuit. Figure 4 shows a common used flyback schematic with AP1681 PSR controller, which can realize output constant current function with very simple circuit.

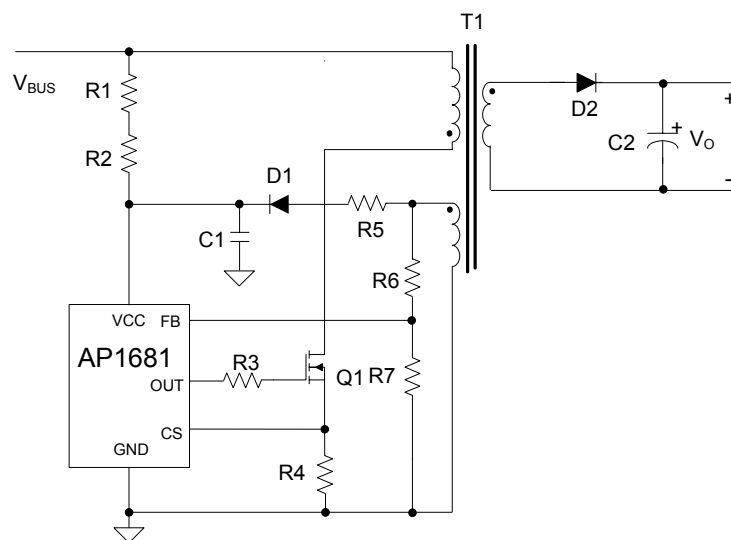

Figure 4. Simple Schematic of PSR

The AP1681 uses PFM control strategy and keeps the flyback converter operating at Discontinuous Current Mode (DCM). Figure 5 shows the basic operation waveform. The output current I_o is

$$I_o = \frac{T_{ons}}{2 \cdot T_{sw}} \cdot I_{pks} \quad (1)$$

Here I_{PKS} is the peak current of secondary side, T_{ONS} is the

time of secondary side "ON", T_{SW} is the switching period. primary peak current I_{PK} is

$$I_{pk} = \frac{V_{cs}}{R_{cs}} \quad (2)$$

$$I_{pks} = N_t \cdot I_{pk} \cdot \eta_{tr} \quad (3)$$

V_{CS} is the primary current sense voltage on CS pin, R_{CS} is the primary current sense resistor, N_t is the primary to

secondary winding turns ratio of transformer and η_{tr} is the transformer conversion ratio considering the transformer power loss and V_{CC} winding output power loss. From above equations, the output current I_O could be

$$I_O = \frac{N_t \cdot T_{ons} \cdot V_{cs} \cdot \eta_{tr}}{2 \cdot T_{sw} \cdot R_{cs}} \quad (4)$$

As to AP1681 control scheme, the turn off voltage

threshold on CS pin is a constant value at non-dimming mode. Therefore, by means of parameter design of N_t , T_{ONS}/T_{SW} and R_{CS} , it can be realized output constant current control with PSR structure. Furthermore, FB pin senses the auxiliary winding voltage of the transformer, which reflects the secondary side output voltage, to carry out Constant Voltage (CV) mode control. The CV mode control can keep output voltage below the rating voltage at no load condition.

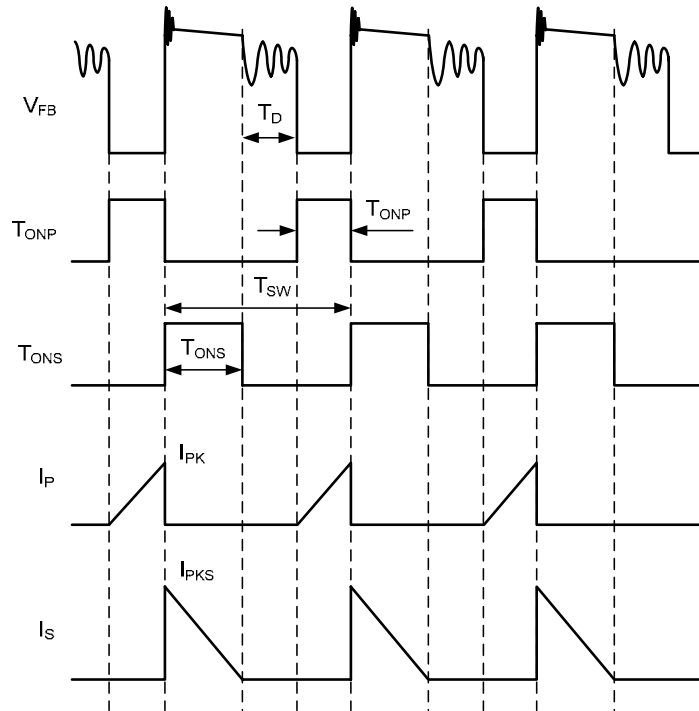

Figure 5. Basic Operation Waveform

4.3 Dimming Principle

The AP1681 regulates the output current according to the DIM pin voltage. From formula (4), I_O can be adjusted accordingly by changing T_{ONS}/T_{SW} if the turn ratio N_t and R_{CS} are fixed. In AP1681, the T_{ONS}/T_{SW} is positively proportional to the voltage on DIM pin whose limited voltage is 3.5V.

Furthermore, there is micro-current which is inversely

proportional to the voltage of DIM pin flows out the CS pin which will cause a voltage across the R_{CS_EXT} (in Figure 6). Then the primary peak current will change with the voltage on DIM pin because the voltage threshold on CS pin is constant. The internal algorithm for T_{ONS}/T_{SW} and V_{CS} realizes exponential dimming curve which is compatible with human eye perception.

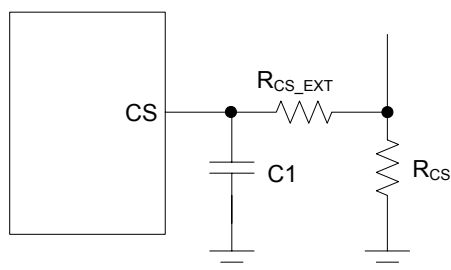

Figure 6. Peripheral Component of CS Pin

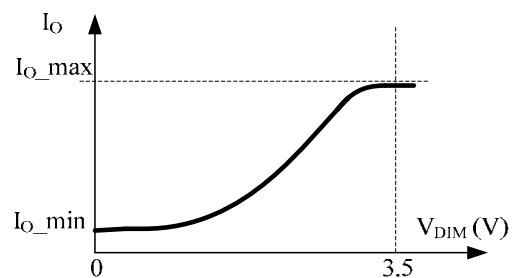

Figure 7. Dimming Curve for AP1681

4.4 Acceleration Start

For LED lighting application, quickly start-up is necessary. In order to reduce start-up time, an acceleration start-up function is embedded in AP1681. At start-up, after VCC voltage is higher than turn on threshold, DIM pin voltage is pulled to zero by internal switch to realize soft start function for next phase. When FB pin voltage keeps below 1.75V, AP1681 system will neglect the dimming function, which means T_{ONS}/T_{SW} keeping the maximum value and CS pin sourcing current keeping zero. Then the switch operates at the maximum I_{PK} mode to provide more energy to secondary side. The acceleration start phase will stop when the FB pin voltage reaches soft start threshold 1.75V, and the DIM pin voltage will start increasing from zero.

4.5 Soft Start and Soft Reloading

After acceleration start phase, AP1681 will enter soft start phase. The DIM pin internal switch is open and DIM pin

voltage will be charged by external source. Because of the external capacitor, DIM pin and the output current are increased gradually to the settle value. The soft start time is determined by DIM pin outside capacitor and external source.

When open load, the system works in CV mode and output voltage is clamped to a higher level. DIM pin is pulled to zero by internal switch. At reloading situation, sensed FB pin voltage drops to below 4V, then DIM pin internal switch is open and DIM pin voltage will be charged by external source. The output current is increased gradually to the settle value. This procedure is called soft reloading stage. This effect will help for safe reloading and prevent output capacitor high discharge current when reloading.

4.6 FB Pin Voltage Region

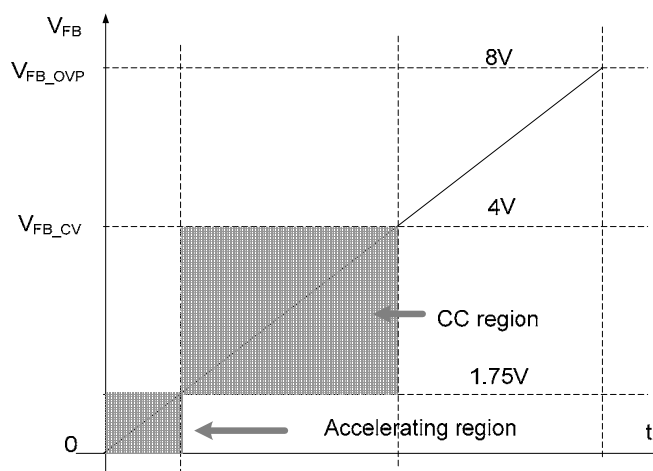

Figure 8. Diagram for the FB Function

The FB pin has several voltage thresholds to realize the different function. When FB pin voltage is below 1.75V, the AP1681 system works in acceleration start phase. The acceleration start phase stop when FB pin sensed voltage reach 1.75V. From 1.75V to 4V, the system works in Constant Current (CC) region, the LED driver normal operation situation. When FB pin voltage is higher than 4V, the system will work in Constant Voltage (CV) state. AP1681 will output 7kHz switching frequency pulse and source the maximum current to CS pin resistor so that the power converter operates with the minimum peak current and very low switching frequency. Generally the transferred power at CV mode is lower than the required power which maintains the power system working at standby mode. With the output voltage decreasing, the FB pin voltage may drop to below 4V, then there will be the

higher power pulse push output voltage rising and power system entering CV mode again. It is recommended to add dummy load at output side to balance the transferred power from primary side at CV mode. If abnormal condition happened, such as fault connection or excess auxiliary winding turns, FB pin voltage reaches to 8V, and then AP1681 will enter FB OVP latch mode protection state. Figure 8 shows the FB pin working regions diagram.

4.7 CS Pin

As for CS block, AP1681 includes two comparator functions: the comparator for primary peak current control and OCP. The CS pin turn off voltage threshold is 0.5V for current loop control. The OCP threshold is 4V. When OCP happened, AP1681 will enter latch mode and switch stops working. The latch mode will be reset when input power off.

The primary peak current depends on the CS pin resistor R_{CS_EXT} when the voltage on DIM pin is changing because there is a micro-current flowing out the CS pin. Under the condition of same DIM pin voltage, the larger value of R_{CS_EXT} , the lower primary peak current. Figure 9 shows the relation curve of primary peak current with DIM pin voltage V_{DIM} and R_{CS_EXT} Value.

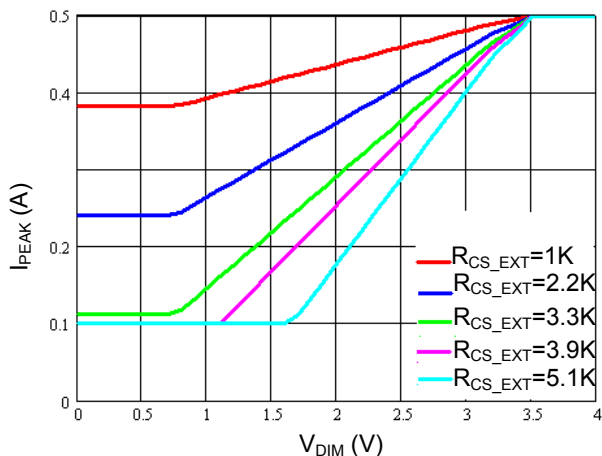

Figure 9. Curve of I_{PEAK} and V_{DIM}

From the curve it can be seen that the higher R_{CS_EXT} value, the lower primary peak current. The lower I_{PEAK} means the LED driver achieve the lower output current, and then the lower darkness LED lighting performance. Usually it is recommended to use 5.1k value CS resistor.

4.8 RD and RI Pin

RD and RI pin feature to set the dimming curve of output current with external resistor. The RD pin resistor R_{RD} , usually recommended as 51k, is used to generate reference bias current for internal dimming function circuit.

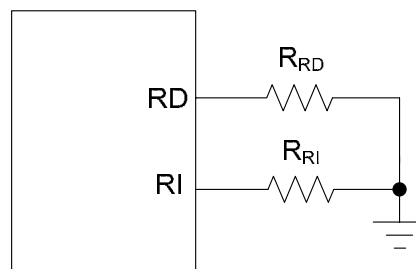

Figure 10. Resistor for RD Pin and RI Pin

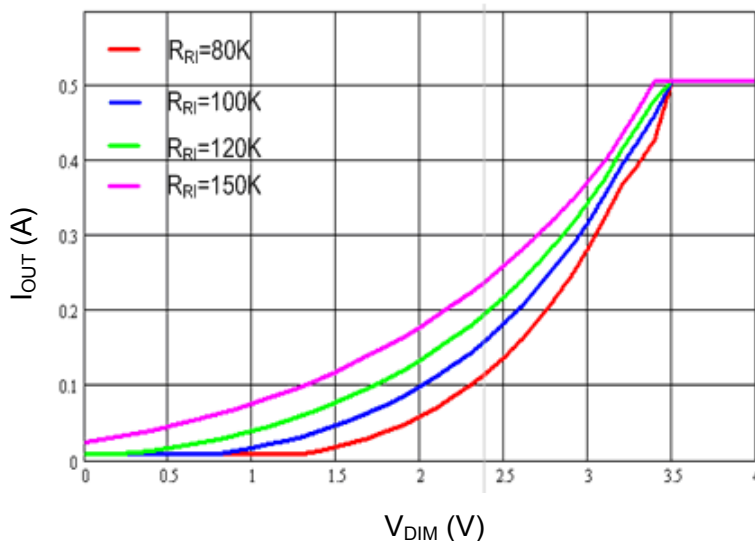

Figure 11. Curve of V_{DIM} and I_{OUT}

The RI pin resistor (R_{RI}) is used to set the dimming curve of output current. Figure 11 is the curve of output current with DIM pin voltage under the different RI resistor. From the curves it can be seen that the LED brightness changes faster with the smaller R_{RI} . The designer can select suitable resistor according to this dimming curve to achieve the required dimming characteristics.

4.9 Max T_{ONP} Protection

When primary side switch turns on, the current will increase because of input voltage and flyback primary inductor. If the sensed CS pin voltage doesn't reach 0.5V over 16.5 μ s, maximum T_{ONP} protection happens, the switch will be turned off immediately.

4.10 Over Temperature Protection (OTP)

For LED application, the LED driver usually works in high ambient temperature. Over temperature protection (OTP) is necessary to avoid improper installation and protect LED lifetime. If AP1681 junction temperature reaches 140°C, OTP happens. The AP1681 system will be shut down. 20°C hysteresis is provided for robust operation. The OTP will be relieved after the IC junction temperature drops below 120°C.

5. Operation Parameter Design and Components Selection for Two Stages

Usually, Boost + PSR flyback topology is suggested for triac dimming LED driver application because of excellent dimming compatibility, no flickering operation, high power factor, low THD and extremely low output current ripple. The boost PFC stage output voltage is constant. So this makes easy for flyback system design. Below is the design procedure only for PSR with AP1681 (please refer to the application of AP1662 for design of boost circuit).

5.1 Calculate the Maximum Turn Ratio of XFMR

In order to guarantee flyback operating at DCM, the maximum turn ratio N_{t_max} is

$$N_{t_max} = \frac{0.978 \cdot V_{bus}}{V_o + V_d} \quad (7)$$

Firstly the designer should determine the turns ratio and then calculate the other design parameter.

5.2 Determine Full Load Working Frequency f_{sw} and Turn Ratio

The switch working frequency of AP1681 is relative to system efficiency and transformer size. Usually 50kHz to 75kHz is recommended to balance the efficiency and size.

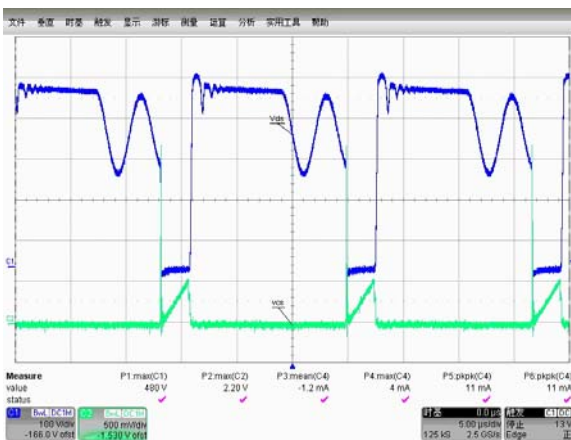

Figure 12. Flyback MOSFET Q2 Drain Voltage and V_{cs} Waveform at Full Load

The output voltage of boost circuit is a constant DC voltage, so the flyback system could be designed to operate on quasi resonant mode to improve efficiency, and the quasi resonant mode could be reached by adjusting f_{sw} , turn ratio and V_{BUS} . Usually f_{sw} and V_{BUS} are determined firstly and the turn ratio is adjusted to realize the quasi resonant mode. (For designing method, please refer to designing file by BCD). Figure 12 shows the working waveform of flyback MOSFET drain voltage and current sensing resistor voltage V_{CS} waveform. The MOSFET works at quasi resonant mode.

5.3 Calculate Current Sensed Resistor

The voltage threshold on CS pin is 0.5V. The primary current sense resistor can be calculated according to equation

$$R_{cs} = \frac{0.127 \cdot N_t \cdot \eta_{tr}}{I_o} \quad (8)$$

η_{tr} is the efficiency of transformer, usually about 0.9. A RC filter is recommended to be added between the CS pin and sampling resistor and the maximum value of resistor is recommended for 5.1k Ω for dimming consideration.

5.4 Calculation of the Inductance of Primary Side--- L_p

The primary peak current is

$$I_{pk} = \frac{I_{pks}}{N_t \cdot \eta_{tr}} = \frac{3.952 \cdot I_o}{N_t \cdot \eta_{tr}} \quad (9)$$

According to the rule of conservation of energy, we can get

$$\frac{1}{2} L_p \cdot I_{pk}^2 \cdot f_{sw} = \frac{P_o}{\eta_p} \quad (10)$$

Here, η_p is the total power conversion efficiency. So, the primary inductance can be calculated by:

$$L_p = \frac{0.128 \cdot P_o \cdot N_t^2 \cdot \eta_{tr}^2}{I_o^2 \cdot f_{sw} \cdot \eta_p} \quad (11)$$

5.5 Calculate the Turns of Primary, Secondary and Auxiliary Sides

The primary winding turns is

$$N_p = \frac{L_p \cdot I_{pk}}{A_e \cdot B_{max}} \quad (12)$$

The turn of secondary winding is

$$N_s = \frac{N_p}{N_t} \quad (13)$$

The turn of auxiliary winding is

$$N_a = \frac{N_s \cdot V_{CC_{max}}}{V_{o_{max}} + V_d} \quad (14)$$

Here, $V_{CC_{max}}$ can be set a typical value of 23V, B_{max} is usually selected between 0.25T and 0.3T.

5.6 Primary MOSFET and Secondary Diode Selection

The maximum voltage on primary MOSFET is

$$V_{ds_{max}} = V_{bus} + N_t \cdot (V_o + V_d) + V_{spike} \quad (15)$$

Where V_{SPIKE} is the spike voltage which is result from the leakage inductance and depends on the primary peak current value and leakage inductance value, it is approximately about 100V to 200V.

Output Power	1W to 10W	10W to 20W	20W to 30W
Output Capacitor	82 μ F to 120 μ F	120 μ F to 180 μ F	180 μ F to 250 μ F

5.8 DIM Pin Elements Selection

The function of DIM pin is to control output current by sensing input AC voltage. Usually a second order filter is connected between rectified AC voltage and DIM pin. The voltage on DIM pin could be set between 3.5V and 4V at typical input voltage and full load. The second order filter which is 100k Ω and 1 micro Farad is recommended to get a small ripple of output current.

5.9 FB Pin Elements Selection

The system will operate at CV mode if the voltage on FB pin reaches 4V. So the voltage on FB pin is recommended to be set at 3.5V at full load.

6. Dimming Consideration

Though PFC circuit makes the whole system act as resistive load for dimmer in theory, improper components value design can still cause flickering when dimming. Here is some design tips for no flickering dimming.

6.1 Design EMI filter capacitor as small as possible. Filter capacitor is necessary to pass EMI standard, but big filter capacitor may cause Triac dimming oscillation when Triac

The maximum drain to source current (RMS value) is

$$I_{d_{max}} = I_{pk} \cdot \sqrt{\frac{D}{3}} = I_{pk} \cdot \sqrt{\frac{T_{onp}}{3T_{sw}}} \quad (16)$$

The maximum voltage on secondary diode is

$$V_{d_{max}} = \frac{V_{bus}}{N_t} + V_{o_{max}} + V_d \quad (17)$$

The maximum average current of secondary diode is output current.

5.7 Output Capacitor Selection

Output capacitor is key factor for output current ripple. Because of Boost PFC stage, there is no line frequency ripple at output side. But there is still the switching frequency output voltage and current ripple since of output capacitor ESR. In order to achieve the lower output ripple performance, it's preferred to select low ESR capacitor. The below table shows the recommended value of output capacitance.

turns on.

6.2 Iron Powder core is suggested for EMI filter because of high saturation flux density. When Triac dimmer turns on, high inrush current will flow into the filter. Iron Powder core inductor can effectively limit the peak inrush and makes the system works stable.

6.3 Quick response of PFC control loop is needed. The designed PFC output feedback capacitor is small to give fast response when dimming.

6.4 Be careful for the AP1661 and AP1681 VCC supply. The PFC is controlled by AP1661 and flyback is controlled by AP1681. The two IC VCC supply comes from the same auxiliary winding of flyback. But the two ICs have different V_{CC} operation range. Usually, a linear regulator is needed for AP1661 power supply.

7. Layout Consideration

The PCB layout rules are highlighted as following:

7.1 The boost converter and flyback converter loop area

should be minimized for better EMI performance.

7.2 The RCD clamp snubber and output rectifier loop areas should be minimized to achieve good EMI performance.

7.3 The power ground and signal ground should be connected by one node. Common connection of GND will introduce disturbances to small signals. The ground of transformer must be separated from the ground of IC in order to pass ESD test.

7.4 C1 should be placed as close as possible to Pin VCC of the AP1681 respectively.

8. Design example

Here is a design example of dimmable LED driver. The specification is:

AC mains RMS voltage: $V_{IN_RMS}=85V$ to $150V$

DC output regulated voltage: $V_O=21V$

Rated output current: $I_O=0.5A$

Flyback full load switching frequency: $f_{sw} = 65kHz$

Expected efficiency: $\eta > 80\%$

Figure 13 shows the designed electrical schematic.

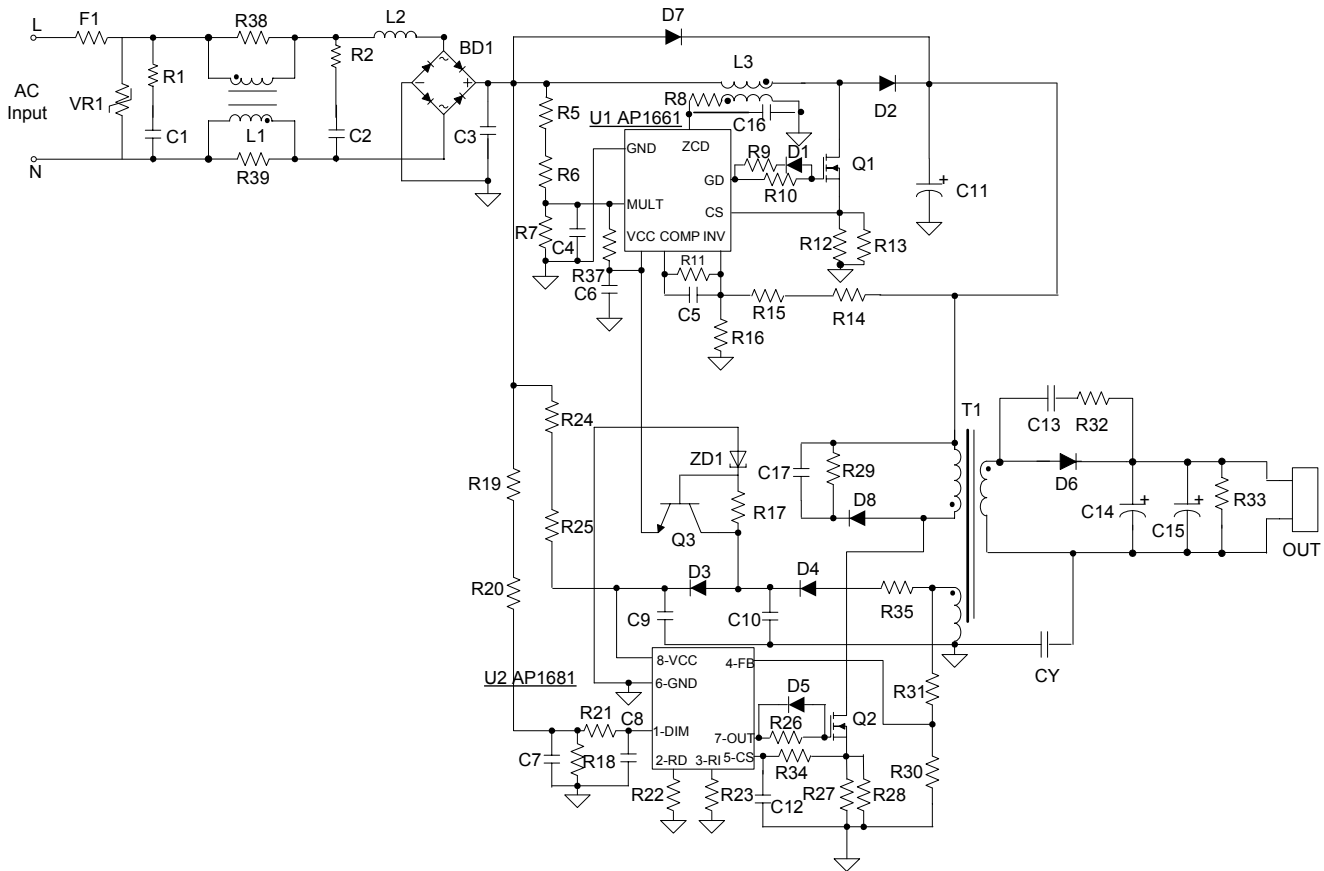

Figure 13. Typical Application Schematic of AP1681 Solution

BOM

Item	Description	QTY
C1	68nF/400V, capacitor CL21	1
C2	100nF/400V, capacitor CL21	1
C3	33nF/400V, capacitor CL21	1
C4	1nF/25V, 0603, ceramic capacitor	1

Item	Description	QTY
C5	100nF/25V, 0603, ceramic capacitor	1
C6	470nF/50V, 1206, ceramic capacitor	1
C7	1 μ F/25V, 0603, ceramic capacitor	1
C8	1 μ F/25V, 0603, ceramic capacitor	1
C9,C10	1 μ F/50V, 1206, ceramic capacitor	2
C11	10 μ F/400V, 105°C, 10mm*11mm electrolytic capacitor low ESR(R<3.5 Ω)	1
C12	10pF/25V, 0603, ceramic capacitor	1
C13	1nF/100V, 0805, ceramic capacitor	1
C14,C15	120 μ F/50V, 105°C, 8mm*11mm electrolytic capacitor low ESR(R<0.15 Ω)	2
C16	2.2nF/275V, Y safety capacitor	1
C17	1nF/500V, 1206, ceramic capacitor	1
D1,D5	Diode, 1N4148, SOD323	2
D2	STTH2L06A, 2A/600V, SMA, ultrafast diode, 60ns	1
D3,D4	BAV21WS, 250V, 200mA, SOD323	2
D6	3A/100V, Schottky Diode, SMA, SS310	1
D7	1A/600V, SMA, US1J	1
D8	1A/1000V, SMA, 1N4007	1
L1	4.5mH, Differential-Mode Inductor, EF16, 250Ts	1
L2	6.8mH, Inductor, 6mm*8mm	1
L3	3mH, Inductor, EE16	1
F1	Fuse, 1A/250V	1
VR1	Varistor 07D471K	1
BD1	Bridge diode, 0.5A/600V, TO-269AA, MB6S	1
R1 to R4	1k Ω , 5%, 1206, resistor	4
R5	1M Ω , 5%, 1206, resistor	1
R6	1.5M Ω , 5%, 1206, resistor	1
R7	15k Ω , 5%, 0603, resistor	1
R8	82k Ω , 5%, 0603, resistor	1
R9	27 Ω , 5%, 0603, resistor	1
R10	330 Ω , 5%, 0603, resistor	1

Item	Description	QTY
R11	100k Ω , 5%,0603 , resistor	1
R12, R13	4.7 Ω , 5%,1206 , resistor	2
R14	2.2M Ω , 5%,1206 , resistor	1
R15	82k Ω , 5%,1206, resistor	1
R16	18k Ω , 5%,0603, resistor	1
R17	10k Ω , 5%, 0603, resistor	1
R18	39k Ω , 5%, 0603, resistor	1
R19,R20	470k Ω , 5%,1206, resistor	2
R21	100k Ω , 5%,0603, resistor	1
R22	51k Ω , 1%,0603, resistor	1
R23	120k Ω , 1%,0603, resistor	1
R24, R25	510k Ω , 5%, 1206, resistor	2
R26	100 Ω , 5%,1206, resistor	1
R27	2.2 Ω , 1%,1206, resistor	1
R28	2.4 Ω , 1%,1206, resistor	1
R29	10M Ω , 5%, 1206, resistor	1
R30	8.2k Ω , 5%,0603, resistor	1
R31	51k Ω , 5%, 1206, resistor	1
R32	47 Ω , 5%, 1206, resistor	1
R33	18k Ω , 5%, 1206, resistor	1
R34	5.1k Ω , 5%, 0603, resistor	1
R35	10 Ω , 5%, 1206, resistor	1
R37	220k Ω ,5%, 0603, resistor	1
R38, R39	10k Ω ,5%, 1206, resistor	2
T1	EE19 10 pin 1.8mH, 5%, Transformer	1
U1	AP1661AMTR-G1, SOIC-8, BCD's IC	1
U2	AP1681MTR-G1, SOIC-8, BCD's IC	1
Q1	MOSFET, Fairchild, SSR4N60B, TO252	1
Q2	MOSFET, ST, P4NK60Z, TO220	1
Q3	Transistor, NPN, BC847,SOT-23	1
Z1	Zener 15V, SOD-80	1

The Flyback transformer use EE19 bobbin and core, $L_p=1.8\text{mH}$, $N_p=140\text{T}$, $N_s=32\text{T}$, $N_a=34\text{T}$.

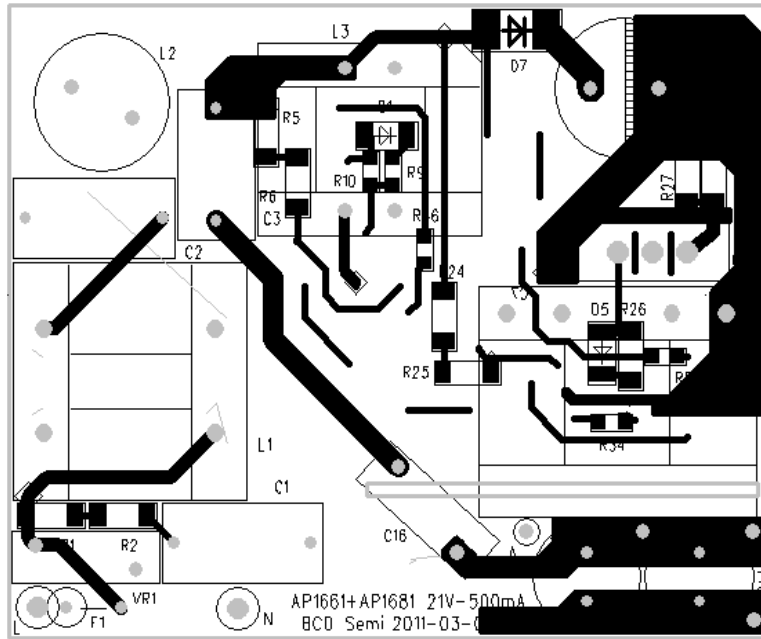

Figure 14. Demo Board PCB and Component Layout (Top View, Real Size 55mm×45mm)

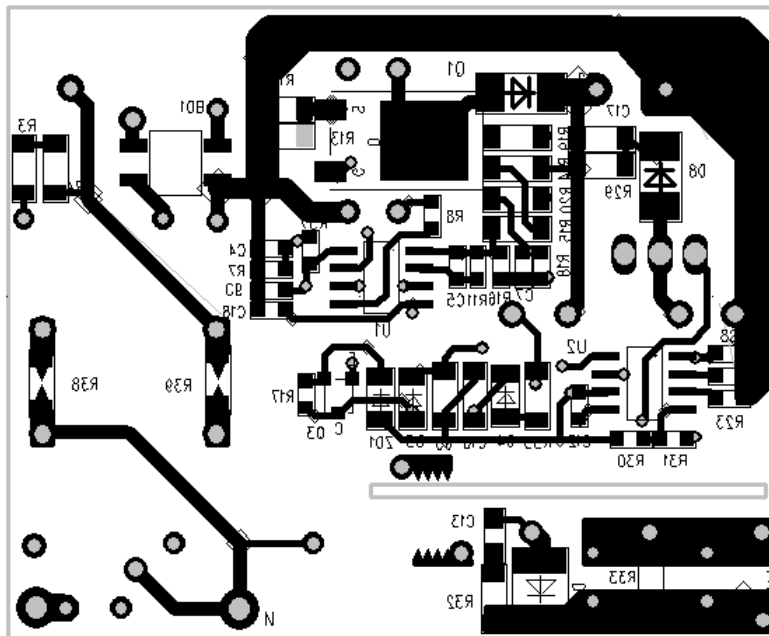

Figure 15. Demo Board PCB and Component Layout (Bottom View, Real Size 55mm×45mm)

The tested I_o Vs. dimmer conduct angle has exponential relation which is compatible with human eye perception.

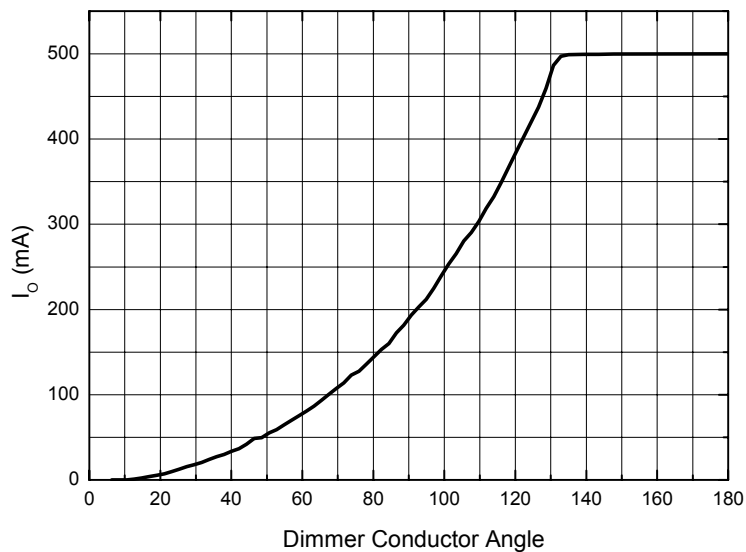

Figure 16. I_o vs. Dimmer Conduct Angle

The input current is in shape with input ac voltage and there is very low inrush current when dimmer begins to conduct. Leading edge and trailing edge type dimmers are

both tested. The input voltage and input current are shown below. Test condition is $V_{IN}=120Vac$.

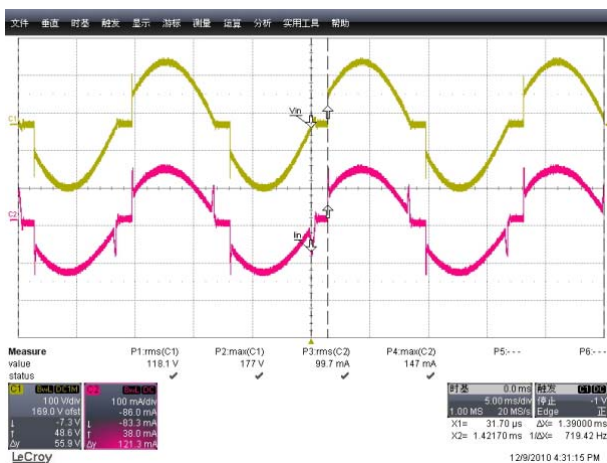

Figure 17. $\theta=150^\circ$ (leading), $I_{PEAK}=147mA$

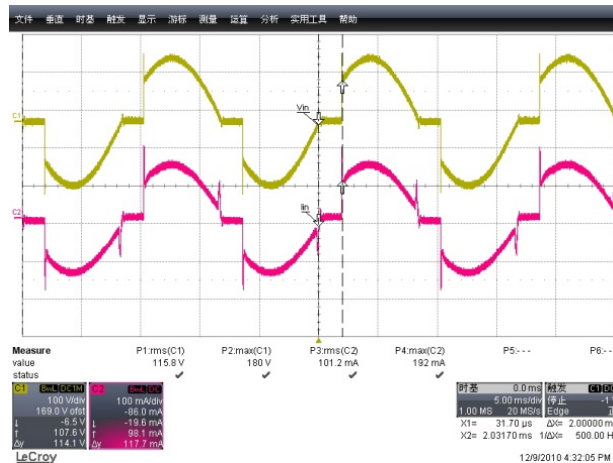
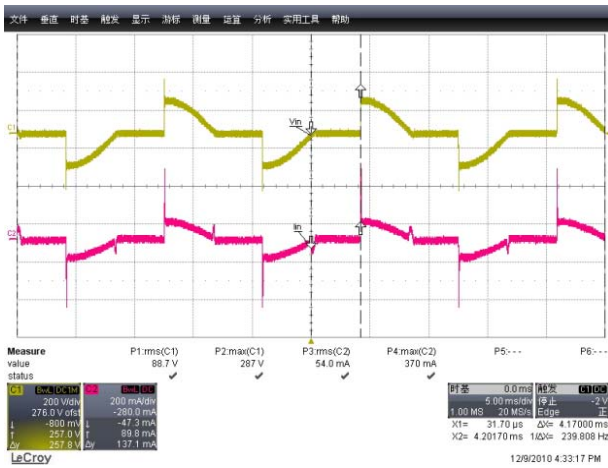
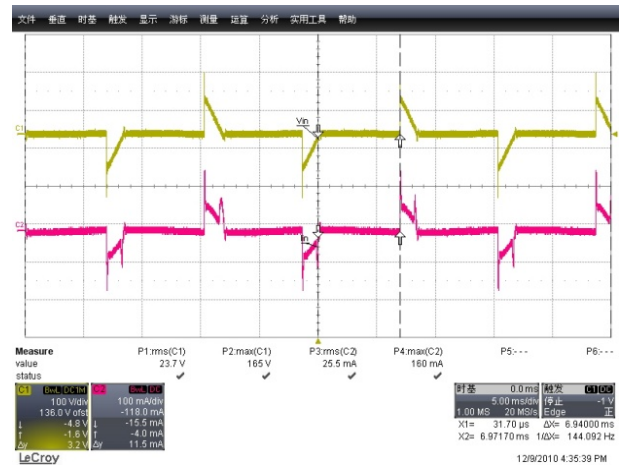
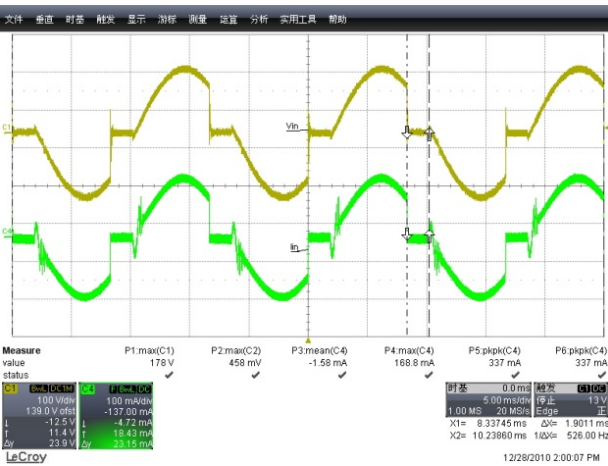
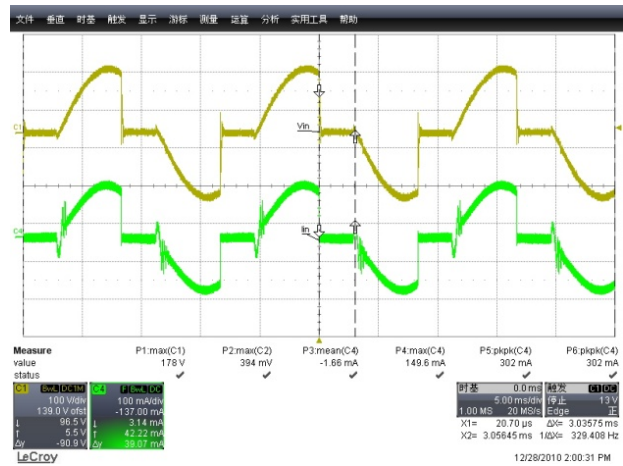
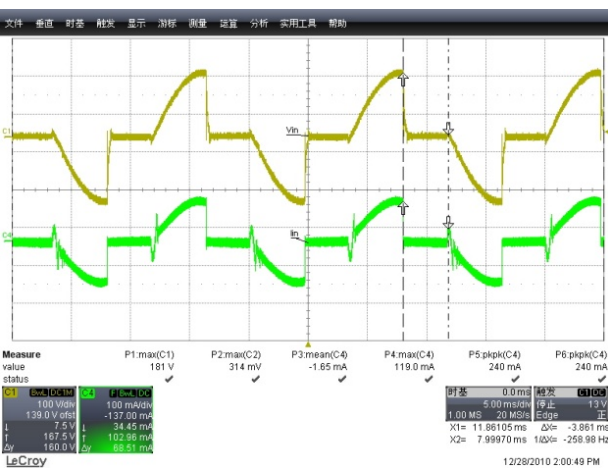
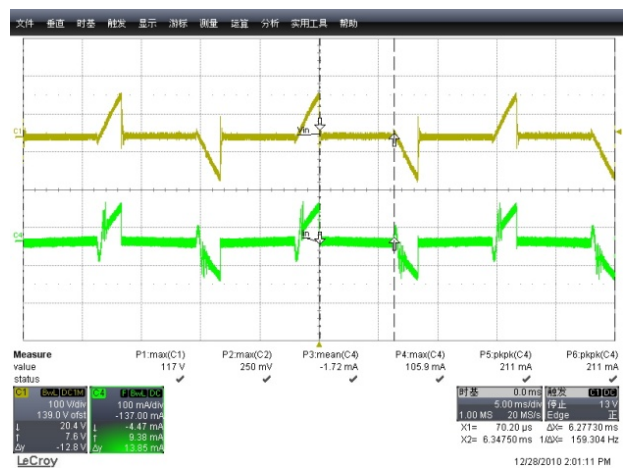

Figure 18. $\theta=135^\circ$ (leading), $I_{PEAK}=192mA$

 Figure 19. $\theta=90^\circ$ (leading), $I_{PEAK}=370\text{mA}$

 Figure 20. $\theta=30^\circ$ (leading), $I_{PEAK}=160\text{mA}$

 Figure 21. $\theta=140^\circ$ (trailing), $I_{PEAK}=169\text{mA}$

 Figure 22. $\theta=115^\circ$ (trailing), $I_{PEAK}=150\text{mA}$

 Figure 23. $\theta=90^\circ$ (trailing), $I_{PEAK}=119\text{mA}$

 Figure 24. $\theta=45^\circ$ (trailing), $I_{PEAK}=106\text{mA}$